

FORM 8486—REVISED
October, 1933
PRINTED IN U. S. A.

LIST OF PARTS

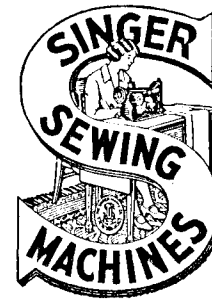

From the library of: Diamond Needle Corp

MACHINE No. 52-67

THE SINGER MANUFACTURING COMPANY

COPYRIGHT, U. S. A., 1916, 1918, 1922 AND 1933,
BY THE SINGER MANUFACTURING CO.
ALL RIGHTS RESERVED FOR ALL COUNTRIES.

INSTRUCTIONS FOR OILING

To insure easy running and prevent unnecessary wear of the parts which are in movable contact, the machine requires oiling and when in continuous use, should be oiled at least twice each day by applying Singer Cloth and Leather Oil to all oil holes marked "Oil" and to all other oiling places.

Genuine Singer Needles should be used
in Singer Machines.
These Needles and their Containers
are marked with the
Company's Trade Mark "SIMANCO." 1

Needles in Containers marked
"For Singer Machines"
are not Singer made needles. 2

INDEX

	PAGE
ACCESSORIES.....	12
FEED ROLLS.....	15
FOOT LIFTER PARTS.....	13
KNEE LIFTER PARTS.....	14
IRON BASE.....	12
LAP SEAM GUIDE.....	12
MACHINE NO. 52-67.....	7
NUMERICAL LIST OF PARTS.....	19
OBSOLETE PARTS.....	16
TAPE HOLDER.....	12
THREAD UNWINDER.....	15

From the library of: Diamond Needle Corp

INSTRUCTIONS FOR ORDERING

In ordering from this list, use **ONLY** the part NUMBER in the **FIRST** column.

The number stamped on a Sewing Machine Part is in every case the number of the single part only.

Every combination of parts sent out as such has its specific number, which, although not stamped on the parts, must be used when ordering the combination.

Each number always indicates the **SAME PART** in whatever list it appears, or for whatever machine.

The letters after some of the numbers indicate the style of finish only, as follows:

- A—Hardened, Polished, Nickel Plated and Buffed
- B—Polished, Nickel Plated and Buffed
- C—Hardened Only
- D—Polished Only
- E—Soft, Not Polished
- F—Hardened and Polished
- H—Blued
- J—Nickel Plated Only
- K—Hardened and Nickel Plated
- L—Brass Plated
- M—Oxidized
- N—Japanned, Dull
- P—Japanned, Bright
- R—Merlized
- T—Copper Plated
- T. A.—Hardened, Polished, Copper and Nickel Plated and Buffed
- T. B.—Copper and Nickel Plated and Polished
- T. J.—Copper and Nickel Plated Only
- T. K.—Hardened, Copper and Nickel Plated
- T. M.—Copper Plated and Oxidized
- T. L.—Copper and Brass Plated
- U—Zinc Plated
- V—Silver Plated
- W—Polished and Nickel Plated
- Y—Black Nickel Plated Only
- Z—Chromium Plated
- Z. B.—Polished, Nickel Plated, Buffed and Chromium Plated
- Z. J.—Nickel and Chromium Plated

These letters **MUST BE USED** when they appear in the list; and **AFTER** the number **as** in the list.

In this series:

- 1 to 1500 and 50001 to 51500 are Screw Numbers
- 1501 to 1800 and 51501 to 51800 are Nut Numbers
- 1801 to 2000 and 51801 to 52000 are Roller Numbers
- 2001 to 50000 and 52001 and upward are numbers of Machine Parts

The figures in the second column refer only to the plates, illustrating the parts, and are **NOT TO BE USED** in ordering.

Parts marked with an asterisk (*) are furnished only when repairs are made at factory.

When ordering parts which differ as to **Gauge** (the distance between seams) the Gauge, as well as the **Number must be given** on order.

LIST OF PARTS COMPLETE FOR

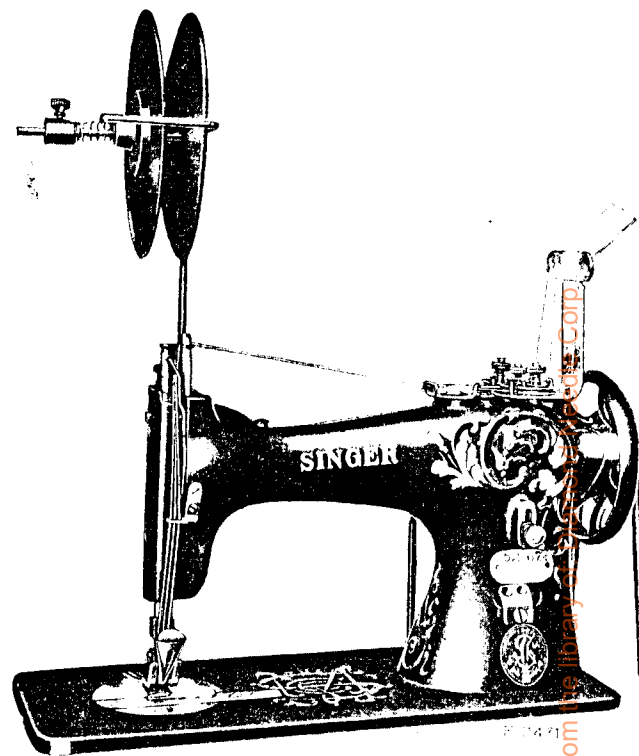

MACHINE No. 52-67

FOR CLOSING AND TAPING THE HEEL SEAMS OF SHOE LININGS IN ONE OPERATION. THREE NEEDLES, THREE HOOKS. GAUGES $\frac{1}{8}$ INCH TO $\frac{3}{8}$ INCH. HAS TAPE GUIDING FOOT AND ADJUSTABLE LAP SEAM GUIDE. BALANCE WHEEL No. 13796. DIAMETER OF BELT GROOVE $2\frac{3}{16}$ INCHES. SPEED 3000.

NO.	PLATE	NAME
*13945	--	Arm.....
13946	--	" 13945 with 453c, 15404, 15486 and two 15405.....
4389	7445	Arm Dowel Pin.....
54897	7442	" Oil Cup.....

NO.	PLATE	NAME
13862	7442	Arm Oil Tube with 29599, for oiling 13799 and 13804.....
13831	7442	Arm Oil Tube (left) with 49092, for oiling 13811.....
13832	7442	Arm Oil Tube (right) with 49092, for oiling 13813.....
13833	—	Arm Oil Tube Bracket.....
13834	7442	“ “ “ “ 13833 with 13831 and 13832.....
898D	7450	Arm Oil Tube Bracket Screw.....
29599	7442	“ “ “ Packing (felt) for 13862....
49092	7442	“ “ “ “ “ “ 13831 and 13832.....
880E	7450	Arm Screw (left).....
138E	7450	“ “ (right).....
13928	8754	“ Shaft.....
13794	7440	“ “ Flanged Bushing (back).....
56006	7442	“ “ “ “ “ Oil Pad (braided cotton).....
446c	2831	Arm Shaft Flanged Bushing (back) Set Screw.....
13795	7440	Arm Shaft Flanged Bushing (front).....
56006	7442	“ “ “ “ “ Oil Pad (braided cotton).....
443c	7450	Arm Shaft Flanged Bushing (front) Set Screw.....
144D	7450	Arm Shaft Screw.....
15196	7441	“ Side Cover.....
286D	7450	“ “ “ Thumb Screw.....
13796	7441	Balance Wheel, 2 $\frac{3}{16}$ in. pulley, with two 448c.....
13797	7441	Balance Wheel Oil Cover.....
210D	7450	“ “ “ “ “ Screw.....
448c	7450	“ “ “ Set Screw.....
*13925	—	Bed.....
13799	7441	Crank Connecting Rod with 13800 and two 145E.....
*13800	—	Crank Connecting Rod Cap.....
145E	7450	“ “ “ “ “ Screw.....
375c	7450	“ “ “ “ “ Hinge Screw.....
1518E	7450	“ “ “ “ “ Nut..
13849	7441	Face Plate.....
190D	7442	“ “ “ Screw.....
13506	7467	Feed Bar.....
315c	8753	“ “ “ Screw Center.....
1519E	7450	“ “ “ “ “ Nut.....
2039	7444	“ Connecting Link.....
378c	7444	“ “ “ “ “ Hinge Screw (long)

NO.	PLATE	NAME
380c	7444	Feed Connecting Link Hinge Screw (short)
1520E	7444	“ “ “ “ “ Nut....
31635	5318	“ Dog, 11 teeth (16 teeth to the inch) for 31691.....
31636	7482	Feed Dog, 11 teeth (16 teeth to the inch) for 31692.....
30243	7483	Feed Dog, 13 teeth (16 teeth to the inch) for 31693.....
191c	7450	Feed Dog Screw.....
13803	7444	“ and Feed Lifting Eccentric with 448c
448c	7450	“ “ “ “ “ Set Screw
13804	7444	“ “ “ “ “ Sleeve....
13805	7440	“ Forked Connection.....
378c	7444	“ “ “ “ “ Hinge Screw....
1520E	7444	“ “ “ “ “ Nut
13806	7440	“ Lifting Rock Shaft.....
13807	—	Feed Lifting Rock Shaft complete, Nos. 2509 and 13806.....
13808	7440	Feed Lifting Rock Shaft Connecting Rod with 43977 and two 145E.....
*43977	—	Feed Lifting Rock Shaft Connecting Rod Cap.....
145E	7450	Feed Lifting Rock Shaft Connecting Rod Cap Screw.....
375c	7450	Feed Lifting Rock Shaft Connecting Rod Hinge Screw.....
1518E	7450	Feed Lifting Rock Shaft Connecting Rod Hinge Screw Nut.....
2509	7444	Feed Lifting Rock Shaft Crank with 157J and 1813.....
157J	7444	Feed Lifting Rock Shaft Crank Clamping Screw.....
1813	7444	Feed Lifting Rock Shaft Crank Roller and Stud.....
307c	7450	Feed Lifting Rock Shaft Screw Center....
1513J	8753	“ “ “ “ “ “ Nut
2164	7444	“ Regulator.....
74E	7444	“ “ “ Hinge Screw.....
747D	7444	“ “ “ Thumb Screw.....
21350	7444	“ “ “ “ “ Stop.....
2047	7440	“ Rock Shaft.....
2046	—	Feed Rock Shaft complete, Nos. 2047 and 2048.....
2048	7444	Feed Rock Shaft Crank with 465c.....
2049	7444	“ “ “ “ “ Pin.....
465c	7444	“ “ “ “ “ Set Screw.....
307c	7450	“ “ “ “ “ Screw Center.....
1513J	8753	“ “ “ “ “ “ Nut.....

From the library of: Raymond Beede Co.

NO.	PLATE	NAME
13617	8753	Looper.....
13727	7467	" Carrier with two 211f and three 853c.....
	211f	Looper Carrier Set Screw.....
13516	7445	" " Shaft.....
13836	7445	" " " Bushing.....
	448c	" " " " Set Screw.....
	217f	" " " " Set Screw.....
13811	7441	" Driving Shaft with 217f.....
13812	7445	" " " Crank with two 1253c.....
	1253c	" " " " Set Screw.....
13813	7445	" " " Link.....
13814	7445	" " " " Hinge Pin.....
	1454c	" " " " " " Set Screw.....
	853c	Looper Set Screw.....
13581	7441	Needle Bar (hollow).....
*13582	7444	" " Connecting Link with 794e.....
13933	—	" " " " 13582 with 13896.....
	794e	Needle Bar Connecting Link Adjusting Screw.....
	881c	Needle Bar Connecting Link Hinge Screw.....
13896	7444	" " " Stud with 1904 and two 175e.....
	175e	Needle Bar Connecting Stud Clamping Screw.....
	1904	Needle Bar Connecting Stud Roller (roller only).....
13816	7440	Needle Bar Crank with 435c and 1293c.....
	1293c	" " " Position Screw.....
	435c	" " " Set Screw.....
13545	7455	" Clamp with three 620f or 50014f, for $\frac{1}{8}$ in. to $\frac{1}{4}$ in. gauges.....
13873	7455	Needle Clamp with three 50014f, for $\frac{3}{16}$ in. gauge and above.....
	2273	Needle Clamp Pin.....
	620f	" Set Screw for 13545.....
	50014f	" " " " $\frac{3}{16}$ in. gauge and above.....
*13818	7445	Oscillating Rock Shaft with 1454c.....
13819	7445	" " " Hinge Pin.....
13820	7445	" " " " Bushing.....
	448c	" " " " " Set Screw.....
	2058	Presser Bar.....
52016	7445	" " Lifter.....
15486	8753	" " " Hinge Stud.....
	453c	" " " " " Set Screw.....

NO.	PLATE	NAME
2953	7445	Presser Bar Lifting Bracket with 453c.....
	453c	2831 " " " " Set Screw.....
3100	7445	" " Spring.....
2070	7445	" " Washer.....
31661	5435	" Foot (strip folding).....
31660	5435	" " (tube).....
	190j	" " Screw.....
	263e	Pressure Regulating Thumb Screw.....
13868	7455	Tension Bracket with five 13589.....
13869	—	Tension Bracket complete, Nos. 828c, 13868, two each 637c, 1547d, three each 1560c, 13710 and six 2921.....
	2921	Tension Disc.....
13589	7442	" " Steady Pin.....
	1560c	" Regulating Thumb Nut.....
	637c	" Screw Stud.....
	828c	" " " for center tension.....
	1547d	" " " Nut.....
13710	7442	" Spring.....
13589	7442	" Thread Guide Pin.....
13929	8753	Thread Controller Post.....
	190j	" " " Screw.....
13845	7442	" " Spring.....
	233j	" " " Screw.....
13930	8753	" " Thread Guide.....
13931	—	Thread Controller complete, Nos. 233j, 13845 and 13929.....
13850	—	Thread Guide (back of arm) four holes.....
13851	7456	" " " " " 13850 with 13862.....
13867	7455	Thread Guide (side of arm) three holes.....
	219j	" " " " " Screw.....
13853	—	" " (top of arm) four holes.....
13854	7457	" " " " " 13853 with 13862.....
	50062j	Thread Guide (top of arm) Screw.....
13910	8753	" Take-up Plate.....
	883b	" " " Screw.....
31691	5318	Throat Plate for 31635.....
31692	7482	" " " 31636.....
31693	7483	" " " 30243.....
	691f	" " " Screw.....
*15404	—	Trade Mark.....
15405	—	" " Rivet.....
13635	1514	Drip Pan with four 1 in. wire nails.....

IRON BASE

NO.	PLATE	NAME
11118	7446	Bed Frame Cushion (leather).....
7263	7446	" " Hinge Connection (long).....
14098	7446	" " " " (short).....
14008	7446	" " " " Pin.....
970D	7446	" " Thumb Screw.....
13697	1511	" " with 970D, 2978, 7263, 14098, two 14008 and four each 11118 and wood screws 1 1/4 in. No. 12.....
2978	1514	Drip Pan.....

ACCESSORIES

NO.	PLATE	NAME
12361	7446	Machine Hinge Connection.....
44139	7446	" " Plate.....
44140	—	Machine Hinge complete, Nos. 12361, 44139 and wood screw 1 1/4 in. No. 14...
12405	7446	Machine Rest (felt).....
41400	7447	" " Pin (wood) 3 1/8 in. long.....
36569	7447	Oiler with 36571.....
36570	—	" 36569, filled with oil.....
36571	7447	" Spout, 1 3/4 in. long, with 36807.....
36807	7446	" " Washer (leather).....
26026	7447	Screw Driver (large).....
26485	7447	" " (small).....
120341	8753	Tweezers (curved).....
8909	7447	Wrench for 1513 and 1518.....
8908	7447	" " 1519 and 1520.....
4822	7447	" " 1521 and 1547.....

LAP SEAM GUIDE

NO.	PLATE	NAME
35818	1517	Lap Seam Guide (left).....
35819	1517	" " " (right).....
35820	—	Lap Seam Guide complete, Nos. 35818 and 35819.....
1423D	7467	Lap Seam Guide Adjusting Screw.....

TAPE HOLDER

(STRAIGHT) 6 IN.

NO.	PLATE	NAME
35821	1518	Bracket Wire.....
35822	1518	Bracket Wire complete, Nos. 26918, 35821 and 35823.....

NO.	PLATE	NAME
*35823	—	Disc.....
*35824	1518	" Hub.....
35825	1518	Disc complete, Nos. 35823 and 35824.....
26918	1518	Tape Guide.....
35826	1517	Tension Adjusting Collar with 286D.....
286D	7450	" " " Thumb Screw...
13211	7446	" " Spring.....
35827	1518	Tape Holder complete, Nos. 13211, 35822, 35825 and 35826.....
190J	7442	Tape Holder Set Screw.....

FOOT LIFTER PARTS

NO.	PLATE	NAME
5596	7448	Bell Crank.....
55848	—	" " 5596 with 5599 and 5601
5599	7448	" " Bracket.....
178E	7450	" " Screw.....
5601	7446	" " Hinge Pin.....
5735	7446	" " Spring.....
5698	7448	Bell Crank complete, Nos. 5735 and 56845
5670	—	Chain, length 26 in. to 35 in., with 56844 and 56845.....

NOTE: When ordering 5670, give length required.

4579	7448	Chain Connecting Link.....
56864	8753	" Hook large.....
56865	8753	" " small.....
13587	7448	Lifting Lever.....
13588	7448	" " Connecting Rod.....
12416	7446	" " " " " " Joint.....
76D	7446	" " " " " " Hinge Screw.....
1521E	7446	Lifting Lever Connecting Rod Lock Nut.....
802D	7450	" " Hinge Screw.....
2763	1511	Rock Shaft.....
12242	1511	" " Hanger with two wood screws 1 in. No. 10.....
6337	1511	Rock Shaft Lifting Bracket with two 356c
12243	1511	" " " " " Hook.....
7125	1516	" " " " " ".....
356c	7450	" " " " " " Set Screw.....
356c	7450	" " " " " " Set Screw.....
2770	1511	" " Stop Dog with 356c.....
356c	7450	" " " " " " Set Screw.....
4880	1516	Rock Shaft complete, Nos. 2763, 2770, 7125, 12243 and two each 6337 and 12242

NO.	PLATE	NAME
4881	1516	Treadle.....
4882	7448	" Shaft.....
4883	7448	" Spring.....
4884	1516	" Stand.....
4885	1516	Treadle complete, Nos. 4879, 4881 to 4884 and two wood screws 1 in. No. 16.....
13725	—	Foot Lifter complete, Nos. 76D, 802D, 1521E, 4880, 4885, 5598, 5670, 12410, 13587, 13588 and two 178E.....

KNEE LIFTER PARTS

NO.	PLATE	NAME
5596	7448	Bell Crank.....
56848	—	" " 5596 with 5599 and 5601.....
5599	7448	" " Bracket.....
178E	7450	" " " Screw.....
5601	7446	" " Hinge Pin.....
5735	7446	" " Spring.....
5598	7448	Bell Crank complete, Nos. 5735 and 56848
13587	7448	Lifting Lever.....
13588	7448	" " Connecting Rod.....
12416	7446	" " " " Joint.....
76D	7446	" " " " " Hinge Screw.....
1521E	7446	Lifting Lever Connecting Rod Lock Nut..
802D	7450	" " Hinge Screw.....
2763	1511	Rock Shaft.....
12242	1511	" " Hanger with two wood screws 1 in. No. 10.....
2765	1511	Rock Shaft Knee Arm.....
2766	1511	" " " " Hub with 356c....
356c	7450	" " " " " Set Screw.....
2768	—	Rock Shaft Knee Arm complete, Nos. 2765 to 2767.....
2767	1511	Rock Shaft Knee Plate with 356c.....
356c	7450	" " " " " Set Screw.....
6337	1511	" " Lifting Bracket with two 356c
2778	1511	" " " " Hook.....
356c	7450	" " " " " Set Screw
356c	7450	" " " " " Set Screw....
2770	1511	" " Stop Dog with 356c.....
356c	7450	" " " " " Set Screw.....
2777	1511	Rock Shaft complete, Nos. 2763, 2768, 2770, 2778, 6337 and two 12242.....
17039	—	Knee Lifter complete, Nos. 76D, 802D, 1521E, 2777, 5598, 12416, 13587, 13588 and two 178E.....

FEED ROLLS

NO.	PLATE	NAME
27971	2830	Feed Roll (lower) with two 446c.....
446c	2831	" " " Set Screw.....
27972	8754	" " " Shaft.....
11411	2831	" " " " Collar with 453c..
453c	2831	" " " " " Set Screw..
27973	2830	" " " " Support.....
27974	2830	" " (upper).....
27975	2831	" " " Bar.....
6533	2831	" " " " Collar with 460c..
460c	2831	" " " " " Set Screw..
27976	2831	" " " " Guide Bracket with 454c.....
454c	2831	Feed Roll (upper) Bar Guide Bracket Set Screw.....
9532	2831	Feed Roll (upper) Bar Lifter with 9533..
81D	2831	" " " " " Hinge Screw
9533	2831	" " " " " Stop Pin....
2065	2831	" " " " Spring.....
27977	2830	" " " Bracket with 453c and 910c.....
910c	2831	Feed Roll (upper) Bracket Set Screw....
2932	2830	" " " Shaft.....
453c	2831	" " " " Set Screw.....
27978	8754	" " Frame.....
27979	8754	" " Pulley (grooved) 9 7/8 in. diam., with 435c.....
435c	2831	Feed Roll Pulley (grooved) Set Screw....
27980	—	Feed Rolls complete, Nos. 81D, 2065, 2932, 6533, 9532, 11411, 27971 to 27979 and six wood screws 1 1/4 in. No. 12.....

THREAD UNWINDER

FOR THREE SPOOLS

NO.	PLATE	NAME
225259	8755	Spool Rest (for one spool) with 201018c..
225257	8755	" " (for two spools) with 201018c..
150203	8755	" " Cushion (felt).....
225388	8755	" " Rod.....
200383c	8753	" " " Set Screw.....
201018c	8753	" " Set Screw.....
202490	8755	" Stand with 200383c.....
225391	8755	Thread Guide.....
201696J	8753	" " Lock Nut.....
225326	8753	" " Position Cup.....

NO.	PLATE	NAME
225324	8755	Thread Guide Rod with 208E and 225322
	208E 7450	" " " Screw.....
225322	8753	" " " Washer.....
259143	8755	Thread Unwinder complete, Nos. 201606J, 202490, 225257, 225259, 225324, 225320, 225388, three each 159203, 225391 and wood screws 7/8 in. No. 12.....
27739	7234	Thread Cone (wood) for large cones.....
225390	7234	" " Holder, for inverted cones..

NOTE: Nos. 27739 and 225390 are used with,
but not included in 259143

OBSOLETE PARTS

NO.	PLATE	NAME
*13789	—	Arm, use 13946.....
13793	7440	" Shaft.....
13809	7445	Looper.....
1253c	7445	" Driving Shaft Link Hinge Pin Set Screw.....
13815	—	Needle Bar Connecting Stud with 1904 and two 640c, use 13896.....
640c	7450	Needle Bar Connecting Stud Clamping Screw for 13815.....
1058c	7445	Presser Bar Lifter Hinge Screw, superseded by 15486, not interchangeable.....
1520E	7444	Presser Bar Lifter Hinge Screw Nut.....
26070	7446	Tape Holder Disc Hub Rivet.....
13844	7442	Thread Controller Post for 13847.....
13846	7442	" " Thread Guide for 13847
13847	—	Thread Controller complete, Nos. 233c, 13844 and 13845.....
13594	7445	Thread Take-up Plate, use 13940.....
27623	5571	" Unwinder Spool Pin for 41435....
155c	7450	" " " " Set Screw for 41435.....
41434	5571	Thread Unwinder Spool Rest for 41435....
41435	—	" " " " 41434 with 1149c and three each 155c and 27623, for 41438.....
1149c	7450	Thread Unwinder Spool Rest Set Screw for 41435.....
27940	5571	Thread Unwinder Spool Stand with 453c, for 41438.....
41514	5571	Thread Unwinder Spool Weight, 4 in. diam., with 41515, for 41438.....

NO.	PLATE	NAME
41515	7446	Thread Unwinder Spool Weight Center Pin for 41514.....
41632	5571	Thread Unwinder Thread Guard with 208E and three 41569, for 41438.....
41569	7446	Thread Unwinder Thread Guard Eyelet for 41632.....
41637	5571	Thread Unwinder Thread Guard Rod (lower) for 41640.....
41638	5571	Thread Unwinder Thread Guard Rod (upper) for 41640.....
41639	5571	Thread Unwinder Thread Guard Rod Coupling with two 456c, for 41640.....
456c	7450	Thread Unwinder Thread Guard Rod Coupling Set Screw for 41639.....
41640	—	Thread Unwinder Thread Guard Rod complete, 30 in. long, for 41438, Nos. 41637 to 41639.....
453c	2831	Thread Unwinder Thread Guard Rod Set Screw for 27940.....
208E	7450	Thread Unwinder Thread Guard Screw for 41632.....
41438	5571	Thread Unwinder complete, Nos. 27940, 41435, 41632, 41640 and three each 27739, 41514 and wood screws 1 in. No. 12.....
35143	7447	Tweezers, 4 in., use 120341 (Accessories)..

Genuine Singer Needles should be used
in Singer Machines.
These Needles and their Containers
are marked with the
Company's Trade Mark "SIMANCO." 1

Needles in Containers marked
"For Singer Machines"
are not Singer made needles. 2

NUMERICAL LIST OF PARTS

- 742 7412 Fea. For outer H. A. Box
- 743 7413 Fea. For outer H. A. Box
- 744 7414 Fea. For outer H. A. Box
- 745 7415 Fea. For outer H. A. Box
- 746 7416 Fea. For outer H. A. Box
- 747 7417 Fea. For outer H. A. Box
- 748 7418 Fea. For outer H. A. Box
- 749 7419 Fea. For outer H. A. Box
- 750 7420 Fea. For outer H. A. Box
- 751 7421 Fea. For outer H. A. Box
- 752 7422 Fea. For outer H. A. Box
- 753 7423 Fea. For outer H. A. Box
- 754 7424 Fea. For outer H. A. Box
- 755 7425 Fea. For outer H. A. Box
- 756 7426 Fea. For outer H. A. Box
- 757 7427 Fea. For outer H. A. Box
- 758 7428 Fea. For outer H. A. Box
- 759 7429 Fea. For outer H. A. Box
- 760 7430 Fea. For outer H. A. Box
- 761 7431 Fea. For outer H. A. Box
- 762 7432 Fea. For outer H. A. Box
- 763 7433 Fea. For outer H. A. Box
- 764 7434 Fea. For outer H. A. Box
- 765 7435 Fea. For outer H. A. Box
- 766 7436 Fea. For outer H. A. Box
- 767 7437 Fea. For outer H. A. Box
- 768 7438 Fea. For outer H. A. Box
- 769 7439 Fea. For outer H. A. Box
- 770 7440 Fea. For outer H. A. Box
- 771 7441 Fea. For outer H. A. Box
- 772 7442 Fea. For outer H. A. Box
- 773 7443 Fea. For outer H. A. Box
- 774 7444 Fea. For outer H. A. Box
- 775 7445 Fea. For outer H. A. Box
- 776 7446 Fea. For outer H. A. Box
- 777 7447 Fea. For outer H. A. Box
- 778 7448 Fea. For outer H. A. Box
- 779 7449 Fea. For outer H. A. Box
- 780 7450 Fea. For outer H. A. Box
- 781 7451 Fea. For outer H. A. Box
- 782 7452 Fea. For outer H. A. Box
- 783 7453 Fea. For outer H. A. Box
- 784 7454 Fea. For outer H. A. Box
- 785 7455 Fea. For outer H. A. Box
- 786 7456 Fea. For outer H. A. Box
- 787 7457 Fea. For outer H. A. Box
- 788 7458 Fea. For outer H. A. Box
- 789 7459 Fea. For outer H. A. Box
- 790 7460 Fea. For outer H. A. Box
- 791 7461 Fea. For outer H. A. Box
- 792 7462 Fea. For outer H. A. Box
- 793 7463 Fea. For outer H. A. Box
- 794 7464 Fea. For outer H. A. Box
- 795 7465 Fea. For outer H. A. Box
- 796 7466 Fea. For outer H. A. Box
- 797 7467 Fea. For outer H. A. Box
- 798 7468 Fea. For outer H. A. Box
- 799 7469 Fea. For outer H. A. Box
- 800 7470 Fea. For outer H. A. Box

NUMERICAL LIST OF PARTS

FOR

MACHINE No. 52-67

- 190 7412 Thread Control
- 191 7413 Thread Control
- 192 7414 Thread Control
- 193 7415 Thread Control
- 194 7416 Thread Control
- 195 7417 Thread Control
- 196 7418 Thread Control
- 197 7419 Thread Control
- 198 7420 Thread Control
- 199 7421 Thread Control
- 200 7422 Thread Control
- 201 7423 Thread Control
- 202 7424 Thread Control
- 203 7425 Thread Control
- 204 7426 Thread Control
- 205 7427 Thread Control
- 206 7428 Thread Control
- 207 7429 Thread Control
- 208 7430 Thread Control
- 209 7431 Thread Control
- 210 7432 Thread Control
- 211 7433 Thread Control
- 212 7434 Thread Control
- 213 7435 Thread Control
- 214 7436 Thread Control
- 215 7437 Thread Control
- 216 7438 Thread Control
- 217 7439 Thread Control
- 218 7440 Thread Control
- 219 7441 Thread Control
- 220 7442 Thread Control
- 221 7443 Thread Control
- 222 7444 Thread Control
- 223 7445 Thread Control
- 224 7446 Thread Control
- 225 7447 Thread Control
- 226 7448 Thread Control
- 227 7449 Thread Control
- 228 7450 Thread Control
- 229 7451 Thread Control
- 230 7452 Thread Control
- 231 7453 Thread Control
- 232 7454 Thread Control
- 233 7455 Thread Control
- 234 7456 Thread Control
- 235 7457 Thread Control
- 236 7458 Thread Control
- 237 7459 Thread Control
- 238 7460 Thread Control
- 239 7461 Thread Control
- 240 7462 Thread Control
- 241 7463 Thread Control
- 242 7464 Thread Control
- 243 7465 Thread Control
- 244 7466 Thread Control
- 245 7467 Thread Control
- 246 7468 Thread Control
- 247 7469 Thread Control
- 248 7470 Thread Control
- 249 7471 Thread Control
- 250 7472 Thread Control
- 251 7473 Thread Control
- 252 7474 Thread Control
- 253 7475 Thread Control
- 254 7476 Thread Control
- 255 7477 Thread Control
- 256 7478 Thread Control
- 257 7479 Thread Control
- 258 7480 Thread Control
- 259 7481 Thread Control
- 260 7482 Thread Control
- 261 7483 Thread Control
- 262 7484 Thread Control
- 263 7485 Thread Control
- 264 7486 Thread Control
- 265 7487 Thread Control
- 266 7488 Thread Control
- 267 7489 Thread Control
- 268 7490 Thread Control
- 269 7491 Thread Control
- 270 7492 Thread Control
- 271 7493 Thread Control
- 272 7494 Thread Control
- 273 7495 Thread Control
- 274 7496 Thread Control
- 275 7497 Thread Control
- 276 7498 Thread Control
- 277 7499 Thread Control
- 278 7500 Thread Control
- 279 7501 Thread Control
- 280 7502 Thread Control
- 281 7503 Thread Control
- 282 7504 Thread Control
- 283 7505 Thread Control
- 284 7506 Thread Control
- 285 7507 Thread Control
- 286 7508 Thread Control
- 287 7509 Thread Control
- 288 7510 Thread Control
- 289 7511 Thread Control
- 290 7512 Thread Control
- 291 7513 Thread Control
- 292 7514 Thread Control
- 293 7515 Thread Control
- 294 7516 Thread Control
- 295 7517 Thread Control
- 296 7518 Thread Control
- 297 7519 Thread Control
- 298 7520 Thread Control
- 299 7521 Thread Control
- 300 7522 Thread Control

From the library of: Diamond Needle Corp

NUMERICAL LIST OF PARTS

NO. PLATE	NAME
74E 7444	Feed Regulator Hinge Screw.....
76D 7446	Lifting Lever Connecting Rod Joint Hinge Screw for 13725 and 17039.....
81D 2831	Feed Roll (upper) Bar Lifter Hinge Screw for 27980.....
138E 7450	Arm Screw (right).....
144D 7450	" Shaft Screw.....
145E 7450	Crank Connecting Rod Cap Screw for 13799.....
145E 7450	Feed Lifting Rock Shaft Connecting Rod Cap Screw for 13808.....
155c 7450	Thread Unwinder Spool Pin Set Screw for 41435, obsolete.....
157J 7444	Feed Lifting Rock Shaft Crank Clamping Screw for 2509.....
175E 7444	Needle Bar Connecting Stud Clamping Screw for 13896.....
178E 7450	Bell Crank Bracket Screw for 13725 and 17039.....
190D 7442	Face Plate Screw.....
190I 7442	Presser Foot Screw.....
190J 7442	Thread Controller Post Screw.....
190I 7442	Tape Holder Set Screw.....
191c 7450	Feed Dog Screw.....
208E 7450	Thread Unwinder Thread Guard Screw for 41632, obsolete.....
208E 7450	Thread Unwinder Thread Guide Rod Screw for 225324.....
210D 7450	Balance Wheel Oil Cover Screw.....
211F 7467	Looper Carrier Set Screw for 13727.....
217F 7450	" " Shaft Set Screw for 13811
219J 7450	Thread Guide (side of arm) Screw.....
233J 7442	" Controller Spring Screw for 13817 and 13931.....
263E 7450	Pressure Regulating Thumb Screw.....
286D 7450	Arm Side Cover Thumb Screw.....
286D 7450	Tape Holder Tension Adjusting Collar Thumb Screw for 35826.....
307c 7450	Feed Lifting Rock Shaft Screw Center....
307c 7450	" Rock Shaft Screw Center.....
315c 8753	" Bar Screw Center.....
356c 7450	Rock Shaft Knee Arm Hub Set Screw for 2766.....
356c 7450	Rock Shaft Knee Plate Set Screw for 2767

NO.	PLATE	NAME
356c	7450	Rock Shaft Lifting Bracket Hook Set Screw for 6337.....
356c	7450	Rock Shaft Lifting Bracket Set Screw for 6337.....
356c	7450	Rock Shaft Stop Dog Set Screw for 2770...
375c	7450	Crank Connecting Rod Hinge Screw.....
375c	7450	Feed Lifting Rock Shaft Connecting Rod Hinge Screw.....
378c	7444	Feed Connecting Link Hinge Screw (long)
378c	7444	" Forked Connection Hinge Screw.....
380c	7444	" Connecting Link Hinge Screw (short)
435c	2831	Needle Bar Crank Set Screw for 13816...
435c	2831	Feed Roll Pulley (grooved) Set Screw for 27979.....
443c	7450	Arm Shaft Flanged Bushing (front) Set Screw.....
446c	2831	Arm Shaft Flanged Bushing (back) Set Screw.....
446c	2831	Feed Roll (lower) Set Screw for 27971.....
448c	7450	Balance Wheel Set Screw for 13796.....
448c	7450	Feed and Feed Lifting Eccentric Set Screw for 13803.....
448c	7450	Looper Carrier Shaft Bushing Set Screw..
448c	7450	Oscillating Rock Shaft Hinge Pin Set Screw
453c	2831	Feed Roll (lower) Shaft Collar Set Screw for 11411.....
453c	2831	Feed Roll (upper) Shaft Set Screw for 27977.....
453c	2831	Presser Bar Lifter Hinge Stud Set Screw for 13946.....
453c	2831	Presser Bar Lifting Bracket Set Screw for 2953.....
453c	2831	Thread Unwinder Thread Guard Rod Set Screw for 27940, obsolete.....
454c	2831	Feed Roll (upper) Bar Guide Bracket Set Screw for 27976.....
456c	7450	Thread Unwinder Thread Guard Rod Coupling Set Screw for 41639, obsolete..
460c	2831	Feed Roll (upper) Bar Collar Set Screw for 6533.....
465c	7444	Feed Rock Shaft Crank Set Screw for 2048
620f	7445	Needle Set Screw for 13545.....
637c	7442	Tension Screw Stud for 13869.....
640c	7450	Needle Bar Connecting Stud Clamping Screw for 13815, obsolete.....
691f	7450	Throat Plate Screw.....
747d	7444	Feed Regulator Thumb Screw.....

NO.	PLATE	NAME
794e	7444	Needle Bar Connecting Link Adjusting Screw for 13582.....
802d	7450	Lifting Lever Hinge Screw for 13725 and 17039.....
828c	7442	Tension Screw Stud, for center tension, for 13869.....
853c	7450	Looper Set Screw for 13727.....
880e	7450	Arm Screw (left).....
881c	7444	Needle Bar Connecting Link Hinge Screw
883b	7445	Thread Take-up Plate Screw.....
898d	7450	Arm Oil Tube Bracket Screw.....
910c	2831	Feed Roll (upper) Bracket Set Screw for 27977.....
970d	7446	Bed Frame Thumb Screw for 13697.....
1058c	7445	Presser Bar Lifter Hinge Screw, obsolete, superseded by 15486, not interchangeable
1149c	7450	Thread Unwinder Spool Rest Set Screw for 41435, obsolete.....
1253c	7445	Looper Driving Shaft Crank Set Screw for 13812.....
1253c	7445	Looper Driving Shaft Link Hinge Pin Set Screw, obsolete.....
1293c	7450	Needle Bar Crank Position Screw for 13816
1423d	7467	Lap Seam Guide Adjusting Screw.....
1454c	8753	Looper Driving Shaft Link Hinge Pin Set Screw for 13818.....
1513j	8753	Feed Lifting Rock Shaft Screw Center Nut
1513j	8753	" Rock Shaft Screw Center Nut.....
1518e	7450	Crank Connecting Rod Hinge Screw Nut..
1518e	7450	Feed Lifting Rock Shaft Connecting Rod Hinge Screw Nut.....
1519e	7450	Feed Bar Screw Center Nut.....
1520e	7444	" Connecting Link Hinge Screw Nut..
1520e	7444	" Forked Connection Hinge Screw Nut
1520e	7444	Presser Bar Lifter Hinge Screw Nut, obsolete.....
1521e	7446	Lifting Lever Connecting Rod Lock Nut for 13725 and 17039.....
1547d	7442	Tension Screw Stud Nut for 13869.....
1560c	7442	" Regulating Thumb Nut for 13869
1813	7444	Feed Lifting Rock Shaft Crank Roller and Stud for 2509.....
1904	7444	Needle Bar Connecting Stud Roller (roller only) for 13815 and 13896.....
2039	7444	Feed Connecting Link.....
2046	—	Feed Rock Shaft complete, Nos. 2017 and 2048.....

NO.	PLATE	NAME
2047	7440	Feed Rock Shaft for 2046.....
2048	7444	" " " Crank with 465c, for 2046.....
2049	7444	Feed Rock Shaft Crank Pin.....
2058	7441	Presser Bar.....
2065	2831	Feed Roll (upper) Bar Spring for 27980...
2070	7445	Presser Bar Spring Washer.....
2164	7444	Feed Regulator.....
2273	7445	Needle Clamp Pin.....
2509	7444	Feed Lifting Rock Shaft Crank with 157J and 1813, for 13807.....
2763	1511	Rock Shaft for 4880 and 2777.....
2765	1511	" " Knee Arm for 2768.....
2766	1511	" " " " Hub with 356c, for 2768.....
2767	1511	Rock Shaft Knee Plate with 356c, for 2768
2768	—	Rock Shaft Knee Arm complete, Nos. 2765 to 2767, for 2777.....
2770	1511	Rock Shaft Stop Dog with 356c, for 4880 and 2777.....
2777	1511	Rock Shaft complete, Nos. 2763, 2768, 2770, 2778, 6337 and two 12242, for 17039.....
2778	1511	Rock Shaft Lifting Bracket Hook for 2777
2921	7442	Tension Disc for 13869.....
2932	2830	Feed Roll (upper) Shaft for 27980.....
2953	7445	Presser Bar Lifting Bracket with 453c....
2978	1514	Drip Pan for 13697.....
3100	7445	Presser Bar Spring.....
4389	7445	Arm Dowel Pin.....
4822	7447	Wrench for 1521 and 1547 (Accessories)...
4879	7448	Chain Connecting Link for 4885.....
4880	1516	Rock Shaft complete, for 13725, Nos. 2763, 2770, 7125, 12243 and two each 6337 and 12242.....
4881	1516	Treadle for 4885.....
4882	7448	" Shaft for 4885.....
4883	7448	" Spring for 4885.....
4884	1516	" Stand for 4885.....
4885	1516	Treadle complete, for 13725, Nos. 4879, 4881 to 4884 and two wood screws 1 in. No. 16.....
5596	7448	Bell Crank for 56848.....
5598	7448	Bell Crank complete, Nos. 5735 and 56848, for 13725 and 17039.....
5599	7448	Bell Crank Bracket for 56848.....
5601	7446	" " Hinge Pin for 56848.....

NO.	PLATE	NAME
5670	—	Chain, length 26 in. to 35 in., with 56864 and 56865, for 13725.....
5735	7446	Bell Crank Spring, for 5598.....
6337	1511	Rock Shaft Lifting Bracket with two 356c, for 4880 and 2777.....
6533	2831	Feed Roll (upper) Bar Collar with 460c, for 27980.....
7125	1516	Rock Shaft Lifting Bracket Hook for 4880.....
7263	7446	Bed Frame Hinge Connection (long) for 13697.....
8908	7447	Wrench for 1519 and 1520 (Accessories)...
8909	7447	" " 1513 and 1518 (Accessories)...
9532	2831	Feed Roll (upper) Bar Lifter with 9533, for 27980.....
9533	2831	Feed Roll (upper) Bar Lifter Stop Pin for 9532.....
11118	7446	Bed Frame Cushion (leather) for 13697...
14411	2831	Feed Roll (lower) Shaft Collar with 453c, for 27980.....
12242	1511	Rock Shaft Hanger with two wood screws 1 in. No. 10, for 4880 and 2777.....
12243	1511	Rock Shaft Lifting Bracket for 4880.....
12361	7446	Machine Hinge Connection for 44140.....
12405	7446	" Rest (felt) Accessories.....
12416	7446	Lifting Lever Connecting Rod Joint for 13725 and 17039.....
13211	7446	Tape Holder Tension Adjusting Spring for 35827.....
13506	7467	Feed Bar.....
13516	7445	Looper Carrier Shaft.....
13545	7455	Needle Clamp with three 620F or 50014F, for $\frac{1}{8}$ in. to $\frac{1}{4}$ in. gauges.....
13581	7441	Needle Bar (hollow).....
*13582	7444	" " Connecting Link with 794E, for 13933.....
13587	7448	Lifting Lever for 13725 and 17039.....
13588	7448	" " Connecting Rod for 13725 and 17039.....
13589	7442	Tension Disc Steady Pin for 13868.....
13589	7442	" Thread Guide Pin.....
13594	7445	Thread Take-up Plate, obsolete, use 13940
13617	8753	Looper.....
13635	1514	Drip Pan with four 1 in. wire nails.....
13697	1511	Bed Frame with 970D, 2978, 7263, 14098, two 14008 and four each 11118 and wood screws $\frac{1}{4}$ in. No. 12.....

NO.	PLATE	NAME
13710	7442	Tension Spring for 13869.....
13725	—	Foot Lifter complete, Nos. 76D, 802D, 1521E, 4880, 4885, 5598, 5670, 12416, 13587, 13588 and two 178E.....
13727	7467	Looper Carrier with two 211F and three 853c.....
*13789	—	Arm, obsolete, use 13946.....
13793	7440	" Shaft, obsolete.....
13794	7440	" " Flanged Bushing (back).....
13795	7440	" " " " (front).....
13796	7441	Balance Wheel, 2 $\frac{3}{16}$ in. pulley, with two 448c.....
13797	7441	Balance Wheel Oil Cover.....
13799	7441	Crank Connecting Rod with 13800 and two 145E, for 13862.....
*13800	—	Crank Connecting Rod Cap for 13799.....
13803	7444	Feed and Feed Lifting Eccentric with 448c.....
13804	7444	Feed and Feed Lifting Eccentric Sleeve for 13862.....
13805	7440	Feed Forked Connection.....
13806	7440	" Lifting Rock Shaft for 13807.....
13807	—	Feed Lifting Rock Shaft complete, Nos. 2509 and 13806.....
13808	7440	Feed Lifting Rock Shaft Connecting Rod with 43977 and two 145E.....
13809	7445	Looper, obsolete.....
13811	7441	" Driving Shaft with 217F, for 13831.....
13812	7445	Looper Driving Shaft Crank with two 1253c.....
13813	7445	Looper Driving Shaft Link.....
13814	7445	" " " " Hinge Pin.....
13815	—	Needle Bar Connecting Stud with 1904 and two 640c, obsolete, use 13896.....
13816	7440	Needle Bar Crank with 435c and 1293c...
*13818	7445	Oscillating Rock Shaft with 1454c.....
13819	7445	" " " " Hinge Pin.....
13820	7445	" " " " " Bushing.....
13831	7442	Arm Oil Tube (left) with 49092, for oiling 13811, for 13834.....
13832	7442	Arm Oil Tube (right) with 49092, for oiling 13813, for 13834.....
13833	—	Arm Oil Tube Bracket for 13834.....
13834	7442	" " " " 13833 with 13831 and 13832.....
13836	7445	Looper Carrier Shaft Bushing.....

NO.	PLATE	NAME
13844	7442	Thread Controller Post for 13847, obsolete
13845	7442	" " Spring for 13847 and 13931.....
13846	7442	Thread Controller Thread Guide for 13847, obsolete.....
13847	—	Thread Controller complete, Nos. 233J, 13844 and 13845, obsolete.....
13849	7441	Face Plate.....
13850	—	Thread Guide (back of arm) four holes, for 13851.....
13851	7456	Thread Guide (back of arm) 13850 with 13862.....
13853	—	Thread Guide (top of arm) four holes, for 13854.....
13854	7457	Thread Guide (top of arm) 13853 with 13862.....
13862	7442	Arm Oil Tube with 29599, for oiling 13799 and 13804, for 13851 and 13854.....
13867	7455	Thread Guide (side of arm) three holes...
13868	7455	Tension Bracket with five 13589, for 13869
13869	—	Tension Bracket complete, Nos. 828c, 13868, two each 637c, 1547D, three each 1560c, 13710 and six 2921.....
13873	7455	Needle Clamp with three 50014F, for $\frac{3}{16}$ in. gauge and above.....
13896	7444	Needle Bar Connecting Stud with 1904 and two 175E, for 13933.....
*13925	—	Bed.....
13928	8754	Arm Shaft.....
13929	8753	Thread Controller Post for 13931.....
13930	8753	" " Thread Guide.....
13931	—	Thread Controller complete, Nos. 233J, 13845 and 13929.....
13933	—	Needle Bar Connecting Link 13582 with 13896.....
13940	8753	Thread Take-up Plate.....
*13945	—	Arm for 13946.....
13946	—	" 13945 with 453c, 15404, 15486 and two 15405.....
14008	7446	Bed Frame Hinge Connection Pin for 13697.....
14098	7446	Bed Frame Hinge Connection (short) for 13697.....
15196	7441	Arm Side Cover.....
*15404	—	Trade Mark for 13946.....
15405	—	" " Rivet for 13946.....
15486	8753	Presser Bar Lifter Hinge Stud for 13946..

NO.	PLATE	NAME
17039	—	Knee Lifter complete, Nos. 76D, 802D, 1521E, 2777, 5598, 12416, 13587, 13588 and two 178E.....
21350	7444	Feed Regulator Thumb Screw Stop.....
26026	7447	Screw Driver (large) Accessories.....
26070	7446	Tape Holder Disc Hub Rivet, obsolete....
26485	7447	Screw Driver (small) Accessories.....
26918	1518	Tape Holder Tape Guide for 35822.....
27623	5571	Thread Unwinder Spool Pin for 41435, obsolete.....
27739	7234	Thread Unwinder Thread Cone (wood) for large cones.....
27940	5571	Thread Unwinder Spool Stand with 453c, for 41438, obsolete.....
27971	2830	Feed Roll (lower) with two 446c, for 27980
27972	8754	“ “ “ Shaft for 27980.....
27973	2830	“ “ “ Support for 27980.....
27974	2830	“ “ (upper) for 27980.....
27975	2831	“ “ (upper) Bar for 27980.....
27976	2831	“ “ “ Guide Bracket with 454c, for 27980.....
27977	2830	Feed Roll (upper) Bracket with 453c and 910c, for 27980.....
27978	8754	Feed Roll Frame for 27980.....
27979	8754	“ “ Pulley (grooved) 9 $\frac{7}{8}$ in. diam., with 435c, for 27980.....
27980	—	Feed Rolls complete, Nos. 81D, 2065, 2932, 6533, 9532, 11411, 27971 to 27979 and six wood screws 1 $\frac{1}{4}$ in. No. 12....
29599	7442	Arm Oil Tube Packing (felt) for 13862....
30243	7483	Feed Dog, 13 teeth (16 teeth to the inch) for 31693.....
31635	5318	Feed Dog, 11 teeth (16 teeth to the inch) for 31691.....
31636	7482	Feed Dog, 11 teeth (16 teeth to the inch) for 31692.....
31660	5435	Presser Foot (tube).....
31661	5435	“ “ (strip folding).....
31691	5318	Throat Plate for 31635.....
31692	7482	“ “ “ 31636.....
31693	7483	“ “ “ 30243.....
35143	7447	Tweezers, 4 in., obsolete, use 120341 (Accessories).....
35818	1517	Lap Seam Guide (left) for 35820.....
35819	1517	“ “ “ (right) for 35820.....
35820	—	Lap Seam Guide complete, Nos. 35818 and 35819.....
35821	1518	Tape Holder Bracket Wire for 35822.....

NO.	PLATE	NAME
35822	1518	Tape Holder Bracket Wire complete, Nos. 26918, 35821 and 35823, for 35827.....
*35823	—	Tape Holder Disc for 35822 and 35825....
*35824	1518	“ “ “ Hub for 35825.....
35825	1518	Tape Holder Disc complete, Nos. 35823 and 35824, for 35827.....
35826	1517	Tape Holder Tension Adjusting Collar with 286D, for 35827.....
35827	1518	Tape Holder (straight) 6 in. disc., complete, Nos. 13211, 35822, 35825 and 35826.....
36569	7447	Oiler with 36571 for 36570.....
36570	—	“ 36569, filled with oil (Accessories)....
36571	7447	“ Spout, 1 $\frac{3}{4}$ in. long, with 36807, for 36569.....
36807	7446	Oiler Spout Washer (leather) for 36571....
41400	7447	Machine Rest Pin (wood) 3 $\frac{1}{8}$ in. long (Accessories).....
41434	5571	Thread Unwinder Spool Rest for 41435, obsolete.....
41435	—	Thread Unwinder Spool Rest 41434 with 1149c and three each 155c and 27623, for 41438, obsolete.....
41438	5571	Thread Unwinder complete, Nos. 27910, 41435, 41632, 41640 and three each 27739, 41514 and wood screws 1 in. No. 12, obsolete.....
41514	5571	Thread Unwinder Spool Weight, 4 inch diam., with 41515, for 41438, obsolete....
41515	7446	Thread Unwinder Spool Weight Center Pin for 41514, obsolete.....
41569	7446	Thread Unwinder Thread Guard Eyelet for 41632, obsolete.....
41632	5571	Thread Unwinder Thread Guard with 208E and three 41569, for 41438, obsolete
41637	5571	Thread Unwinder Thread Guard Rod (lower) for 41610, obsolete.....
41638	5571	Thread Unwinder Thread Guard Rod (upper) for 41640, obsolete.....
41639	5571	Thread Unwinder Thread Guard Rod Coupling with two 456c, for 41640, obsolete.....
41640	—	Thread Unwinder Thread Guard Rod complete, 30 in. long, for 41438, Nos. 41637 to 41639, obsolete.....
*43977	—	Feed Lifting Rock Shaft Connecting Rod Cap for 13808.....

NO.	PLATE	NAME
44139	7446	Machine Hinge Plate for 44140.....
44140	—	Machine Hinge complete, Nos. 12361, 44139 and wood screws 1¼ in. No. 14..
49092	7442	Arm Oil Tube Packing (felt) for 13831 and 13832.....
50014F	7445	Needle Set Screw, for ⅜ in. gauge and above, for 13545 and 13873.....
50062J	7450	Thread Guide (top of arm) Screw.....
52016	7445	Presser Bar Lifter.....
54897	7442	Arm Oil Cup.....
56006	7442	" Shaft Flanged Bushing (back) Oil Pad (braided cotton).....
56006	7442	Arm Shaft Flanged Bushing (front) Oil Pad (braided cotton).....
56818	—	Bell Crank 5596 with 5599 and 5601, for 5598
56864	8753	Chain Hook (large) for 5670.....
56865	8753	" " (small) for 5670.....
120341	8753	Tweezers (curved) Accessories.....
150203	8755	Thread Unwinder Spool Rest Cushion (felt) for 259143.....
200383c	8753	Thread Unwinder Spool Rest Rod Set Screw for 202490.....
201018c	8753	Thread Unwinder Spool Rest Set Screw for 225259.....
201696J	8753	Thread Unwinder Thread Guide Lock Nut for 259143.....
202490	8755	Thread Unwinder Spool Stand with 200383c, for 259143.....
225257	8755	Thread Unwinder Spool Rest (for two spools) with 201018c, for 259143.....
225259	8755	Thread Unwinder Spool Rest (for one spool) with 201018c, for 259143.....
225322	8753	Thread Unwinder Thread Guide Rod Washer for 225324.....
225324	8755	Thread Unwinder Thread Guide Rod with 208E and 225322, for 259143.....
225326	8753	Thread Unwinder Thread Guide Position Cup for 259143.....
225388	8755	Thread Unwinder Spool Rest Rod for 259143.....
225390	7234	Thread Unwinder Thread Cone Holder, for inverted cones.....
225391	8755	Thread Unwinder Thread Guide for 259143
259143	8755	Thread Unwinder complete (for three spools), Nos. 201696J, 202490, 225257, 225259, 225324, 225326, 225388, three each 150203, 225391 and wood screws ¾ No. 12.....

ILLUSTRATIONS OF PARTS
FOR
MACHINE No. 52-67

PLATE 1511—ONE-FOURTH SIZE

13697

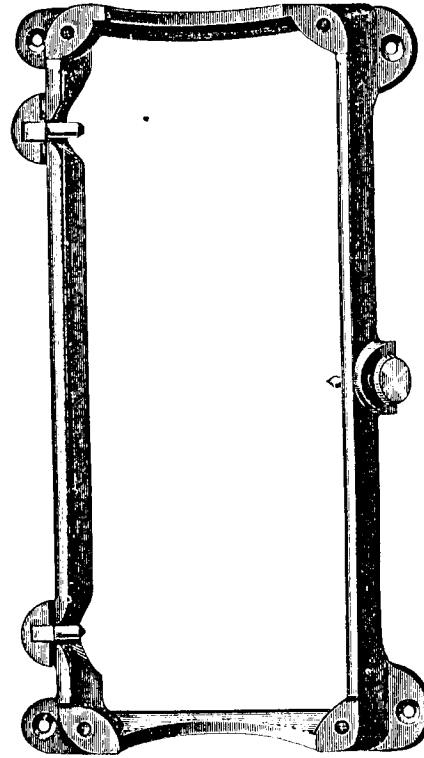

12243

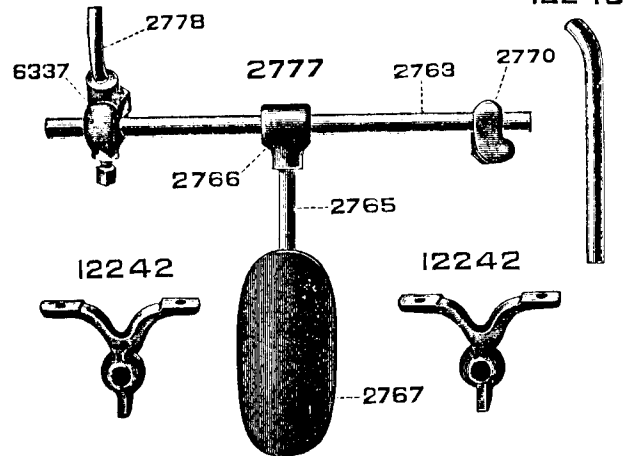

ILLUSTRATIONS OF PARTS

FOR

MACHINE NO. 63

20400 575
20401 576
20402 577
20403 578
20404 579
20405 580
20406 581
20407 582
20408 583
20409 584
20410 585
20411 586
20412 587
20413 588
20414 589
20415 590
20416 591
20417 592
20418 593
20419 594
20420 595
20421 596
20422 597
20423 598
20424 599
20425 600
20426 601
20427 602
20428 603
20429 604
20430 605
20431 606
20432 607
20433 608
20434 609
20435 610
20436 611
20437 612
20438 613
20439 614
20440 615
20441 616
20442 617
20443 618
20444 619
20445 620
20446 621
20447 622
20448 623
20449 624
20450 625
20451 626
20452 627
20453 628
20454 629
20455 630
20456 631
20457 632
20458 633
20459 634
20460 635
20461 636
20462 637
20463 638
20464 639
20465 640
20466 641
20467 642
20468 643
20469 644
20470 645
20471 646
20472 647
20473 648
20474 649
20475 650
20476 651
20477 652
20478 653
20479 654
20480 655
20481 656
20482 657
20483 658
20484 659
20485 660
20486 661
20487 662
20488 663
20489 664
20490 665
20491 666
20492 667
20493 668
20494 669
20495 670
20496 671
20497 672
20498 673
20499 674
20500 675

PLATE 1514—ONE-FOURTH SIZE

13635

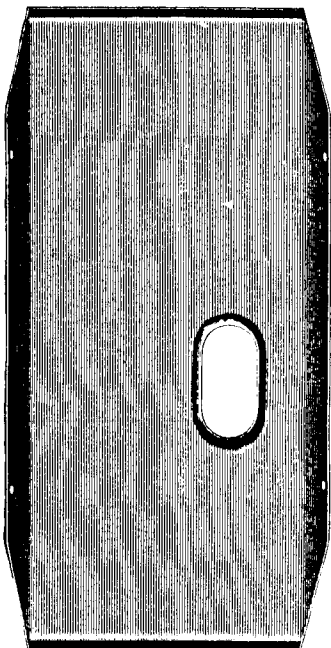

2978

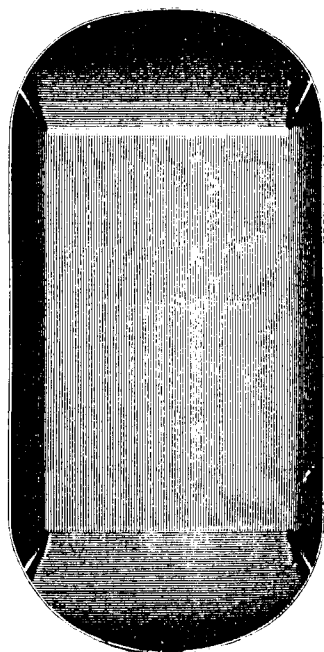

PLATE 1516—ONE-FOURTH SIZE

12242



12242



4880

6337

2770

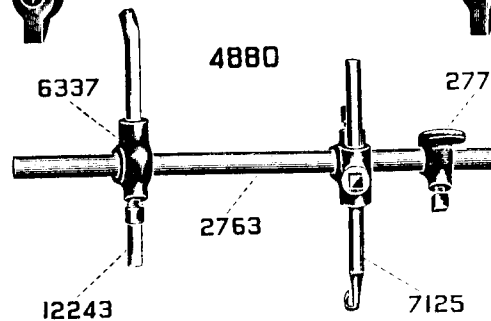

12243

7125

27724



4885

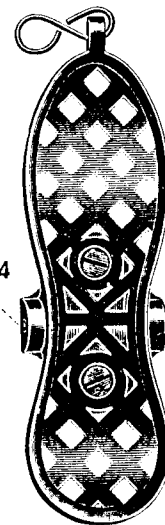

4881

4884

From the library of: Diamond Needle Corp

PLATE 1517—FULL SIZE

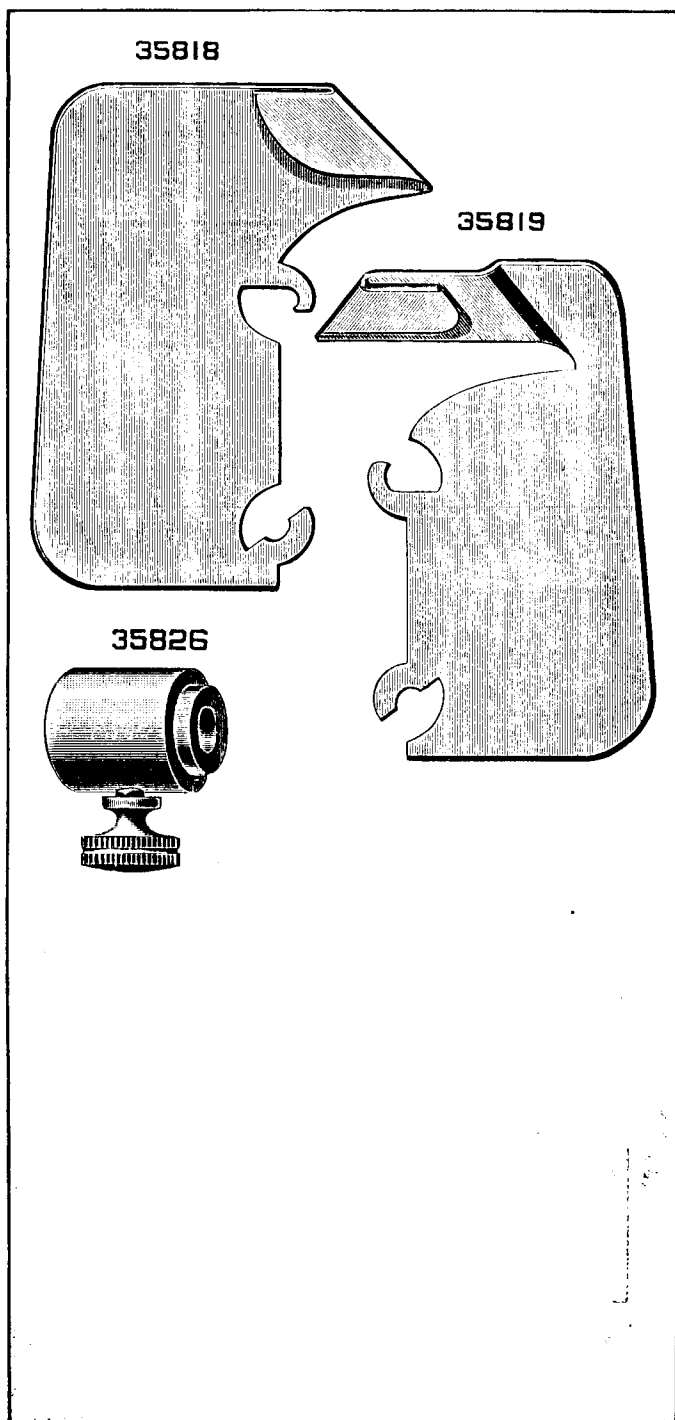

PLATE 1518—ONE-HALF SIZE

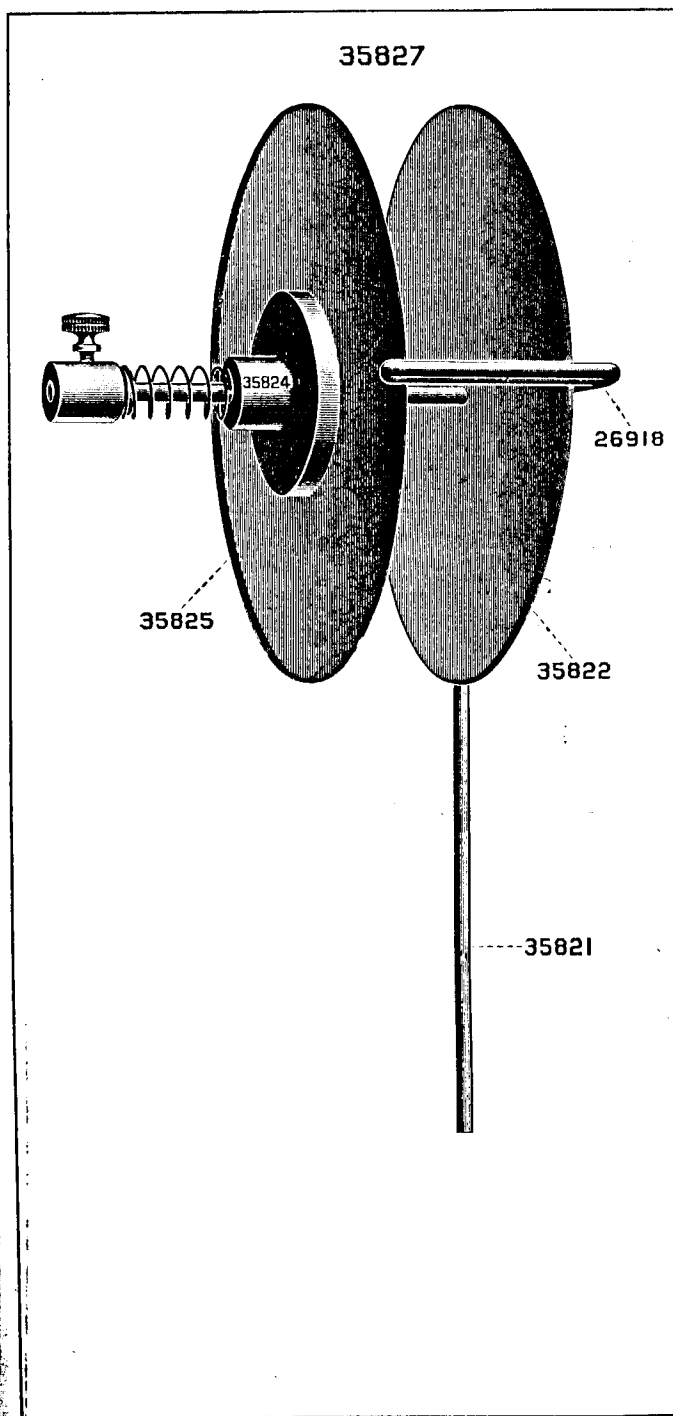

PLATE 2830—ONE-HALF SIZE

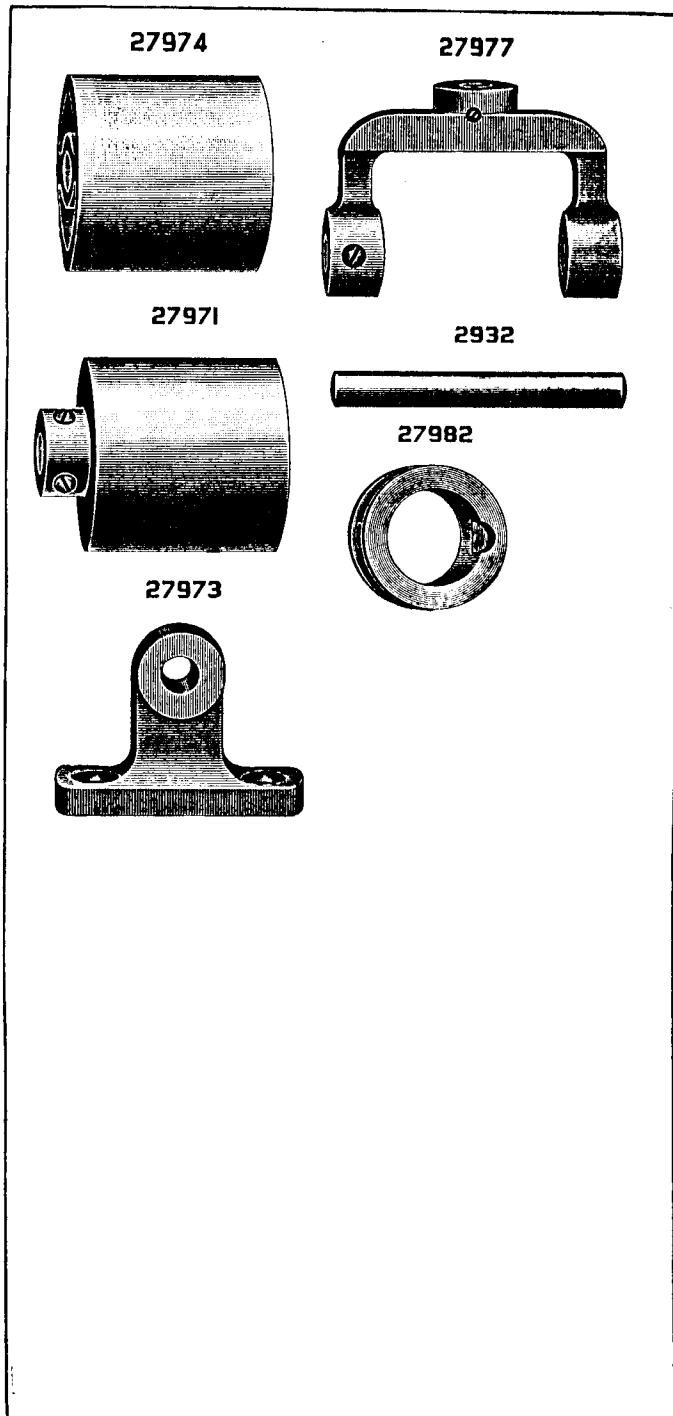

PLATE 2831—FULL SIZE

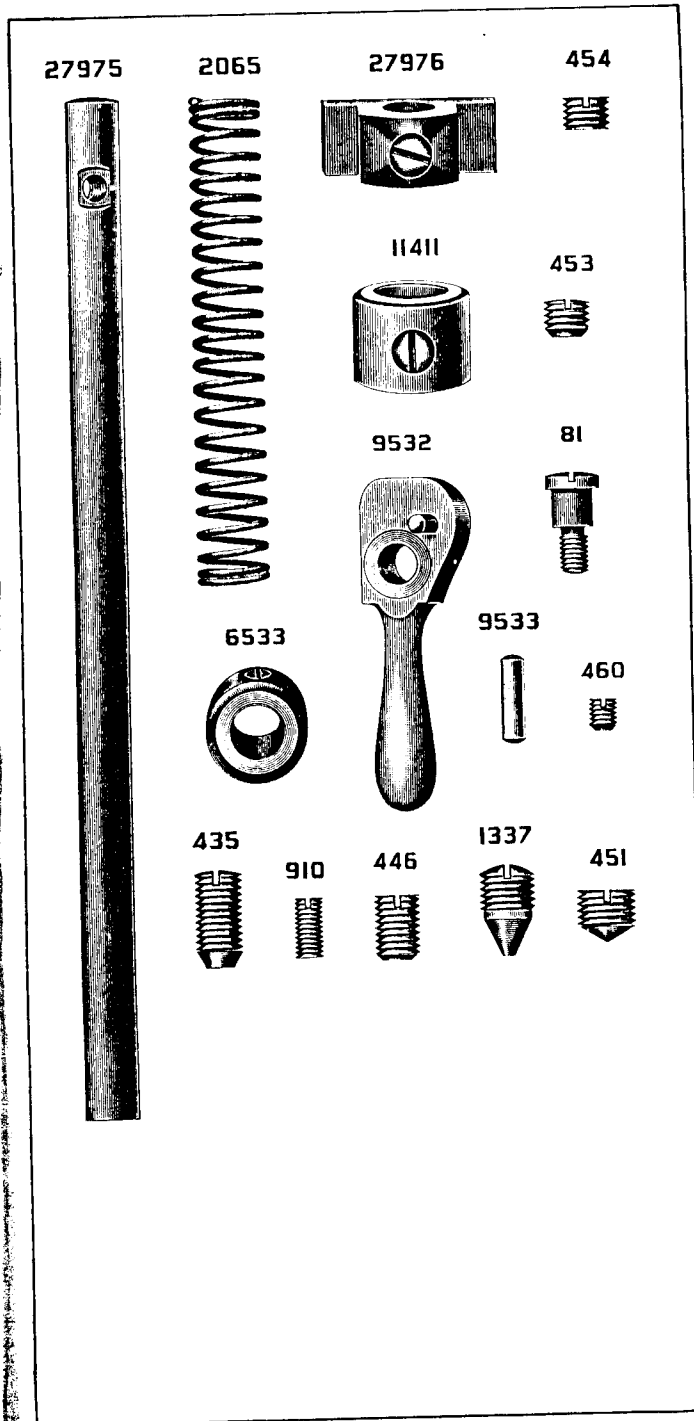
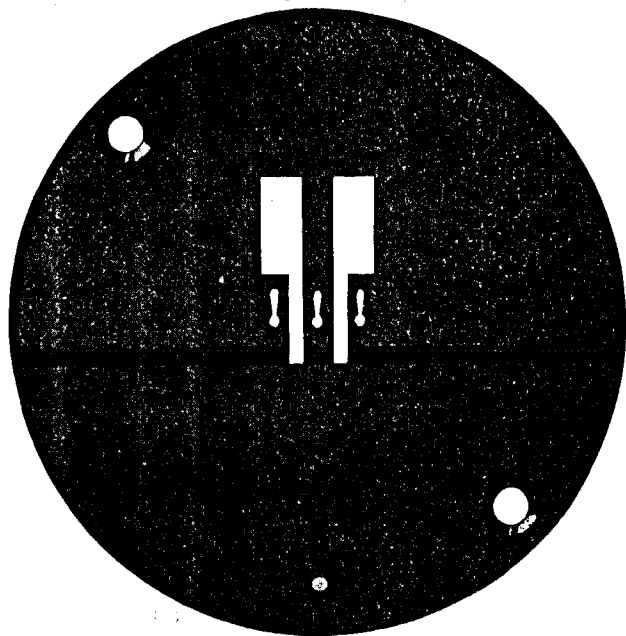

PLATE 5318—FULL SIZE

31691



31635



PLATE 5435—FULL SIZE

31660

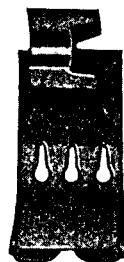

31660



31661

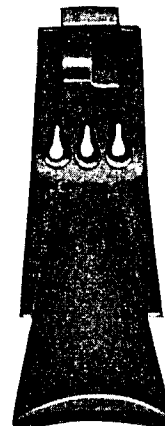

31661



PLATE 5571—ONE-FOURTH SIZE

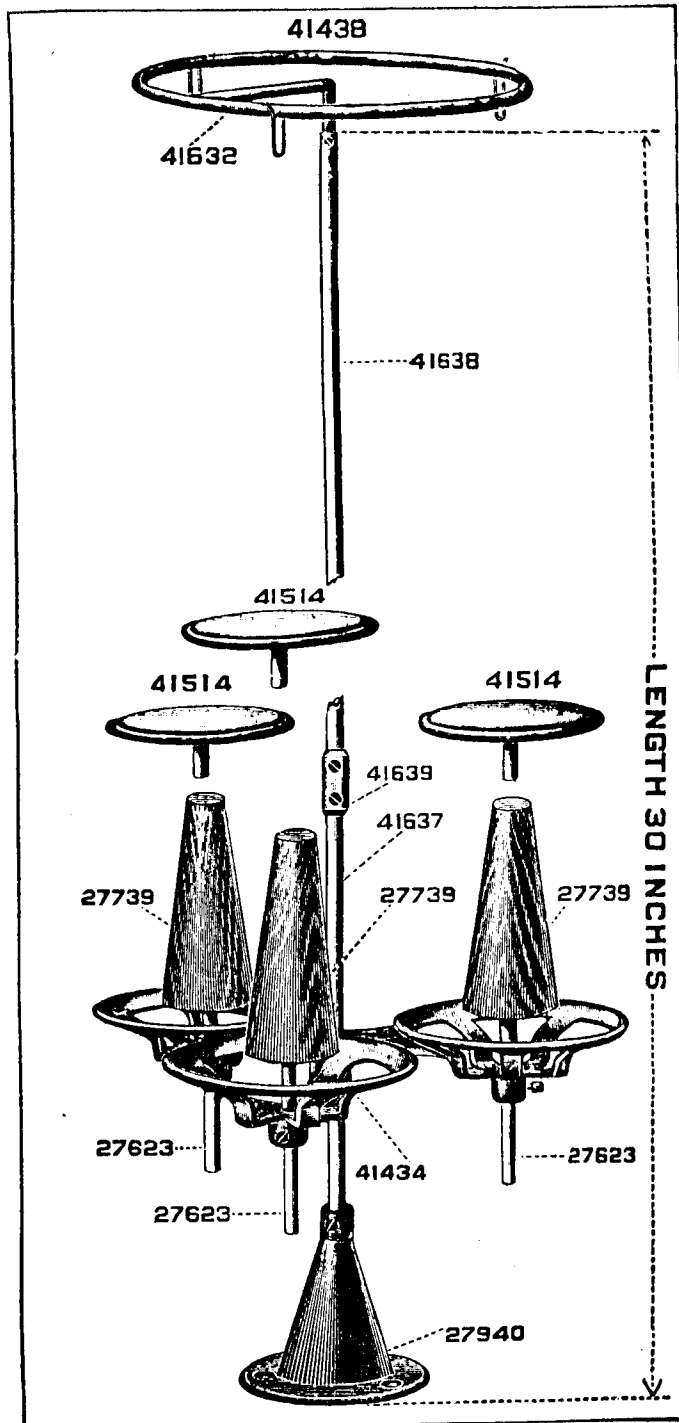

PLATE 7234—ONE-HALF SIZE

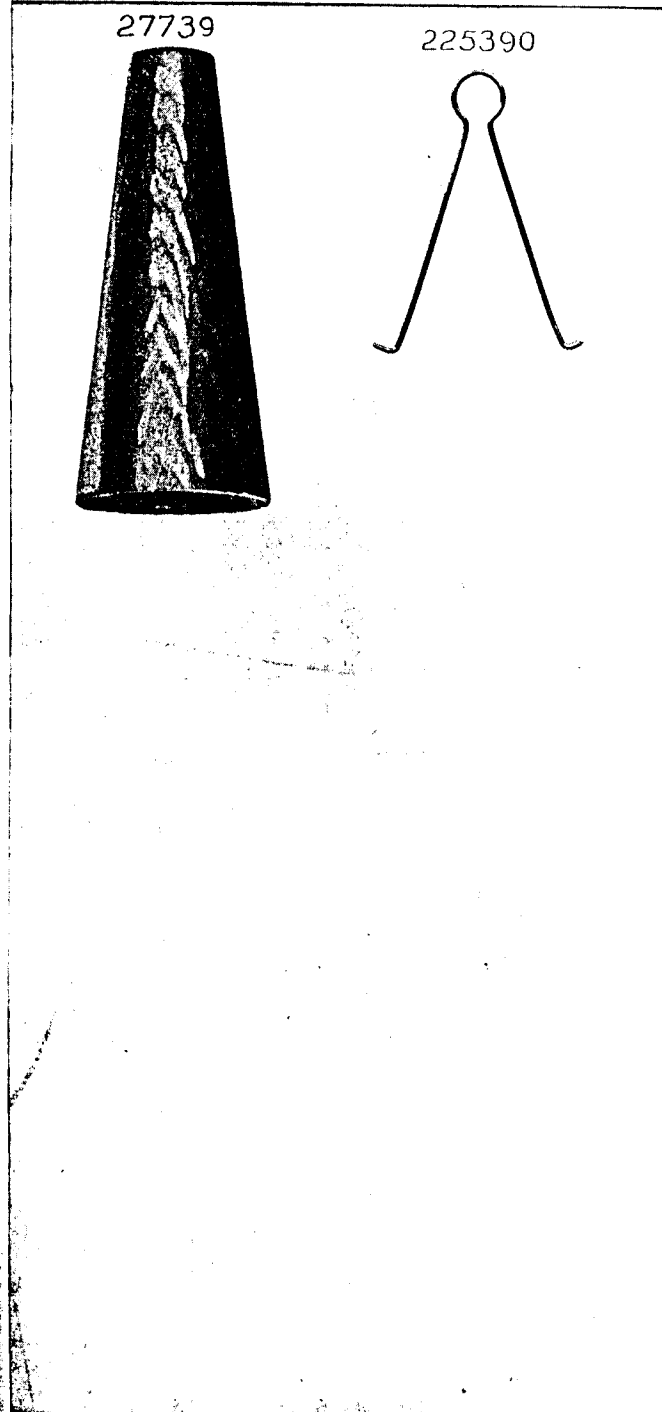

PLATE 7440—ONE-HALF SIZE

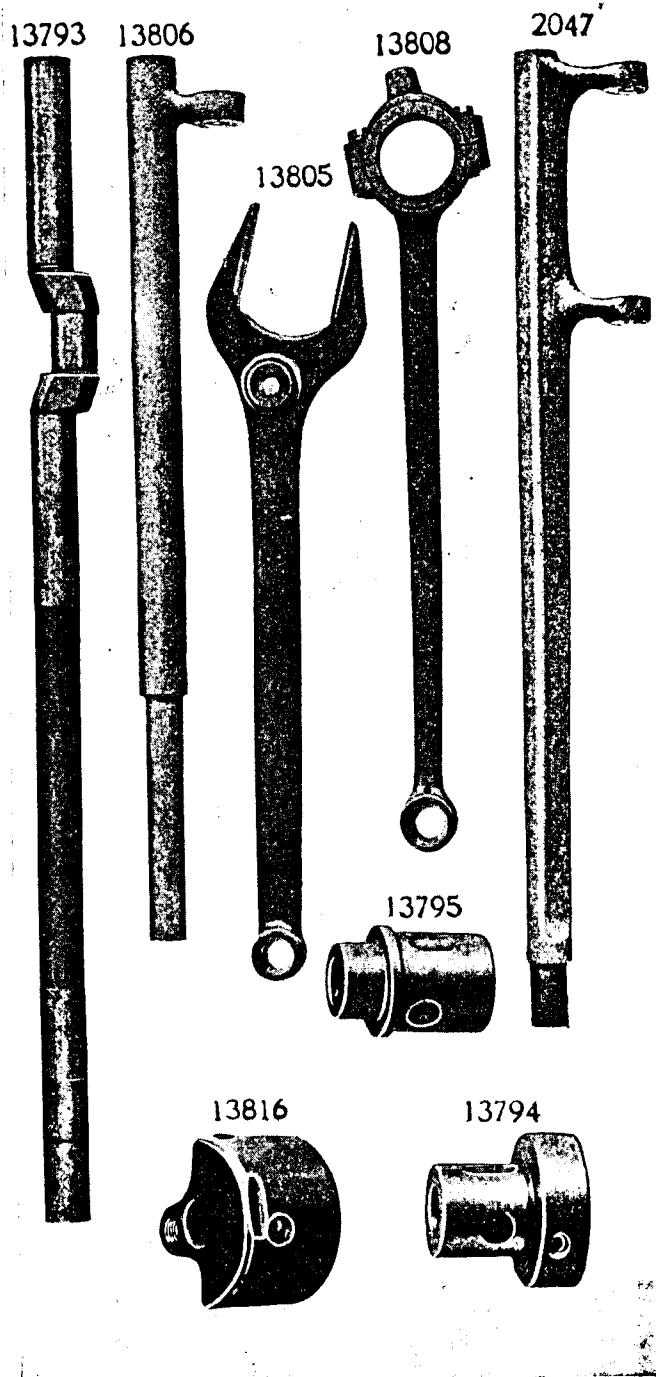
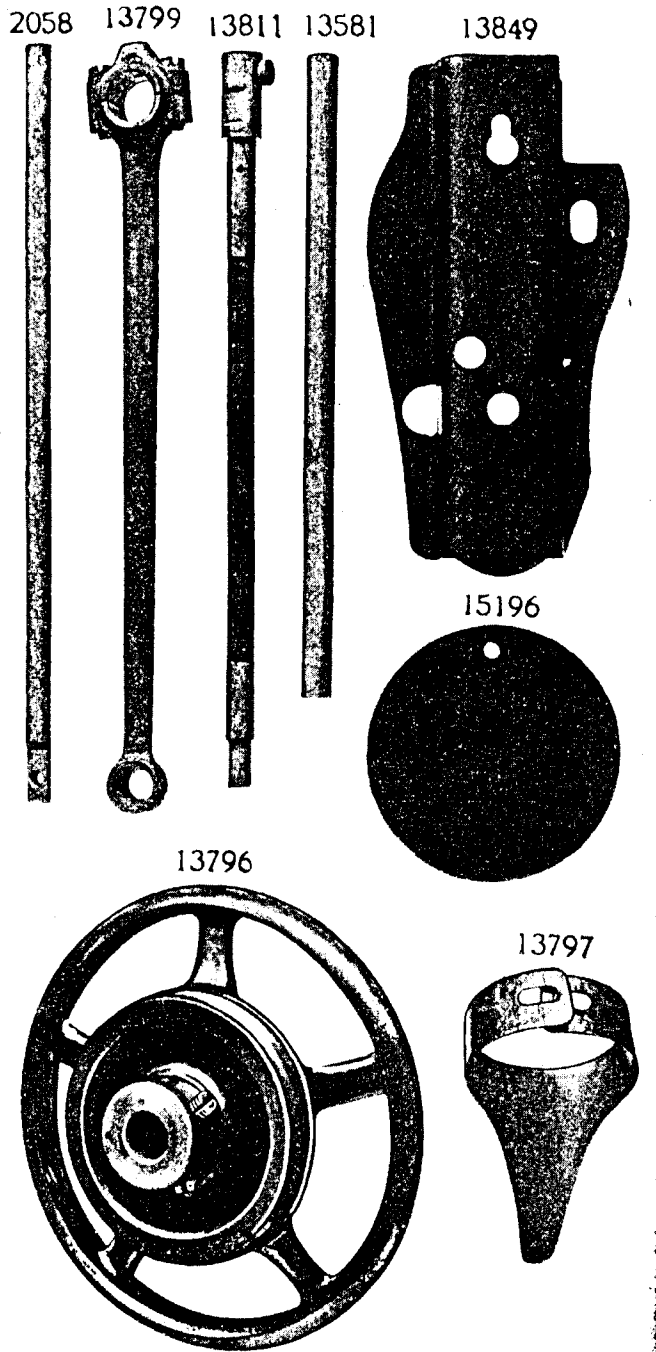

PLATE 7441—ONE-HALF SIZE



From the library of: Diamond Needle Corp

PLATE 7442—FULL SIZE

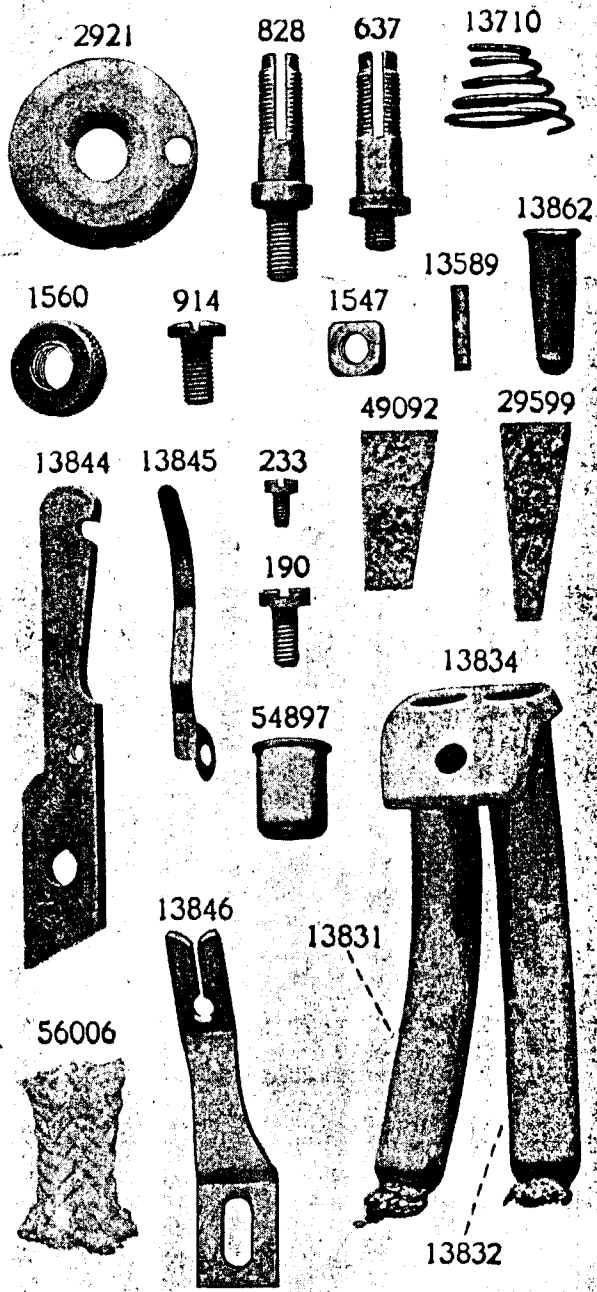
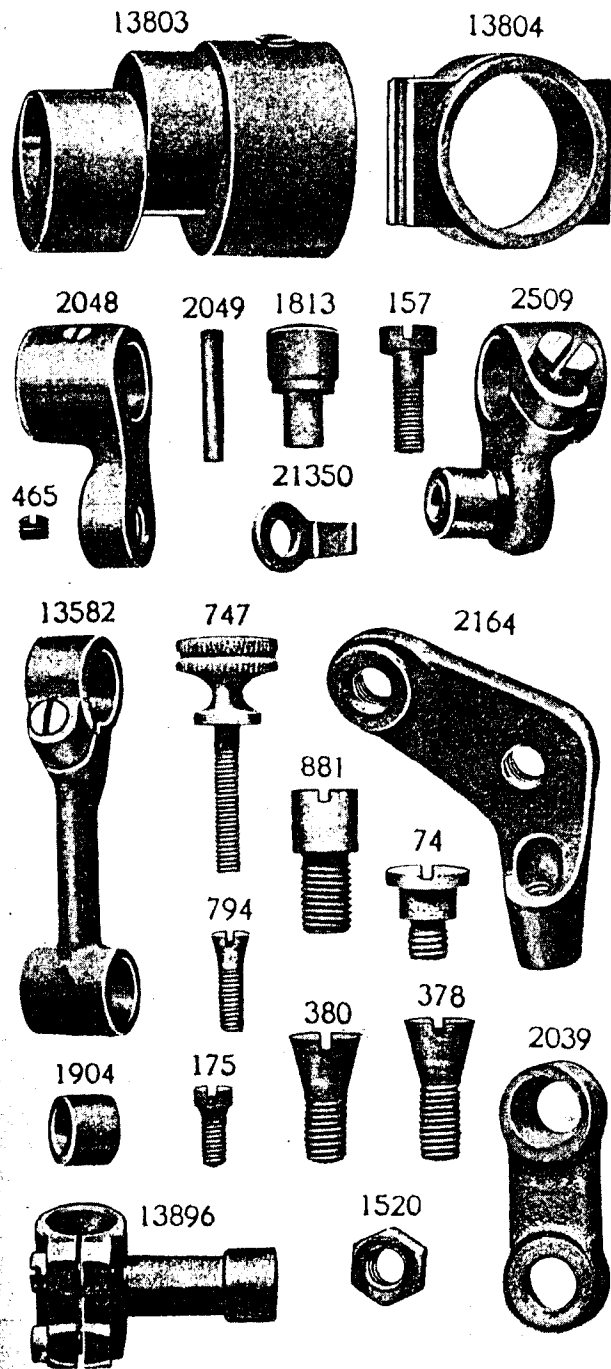

PLATE 7444—FULL SIZE



From the library of: Diamond Needle Corp

PLATE 7445—FULL SIZE

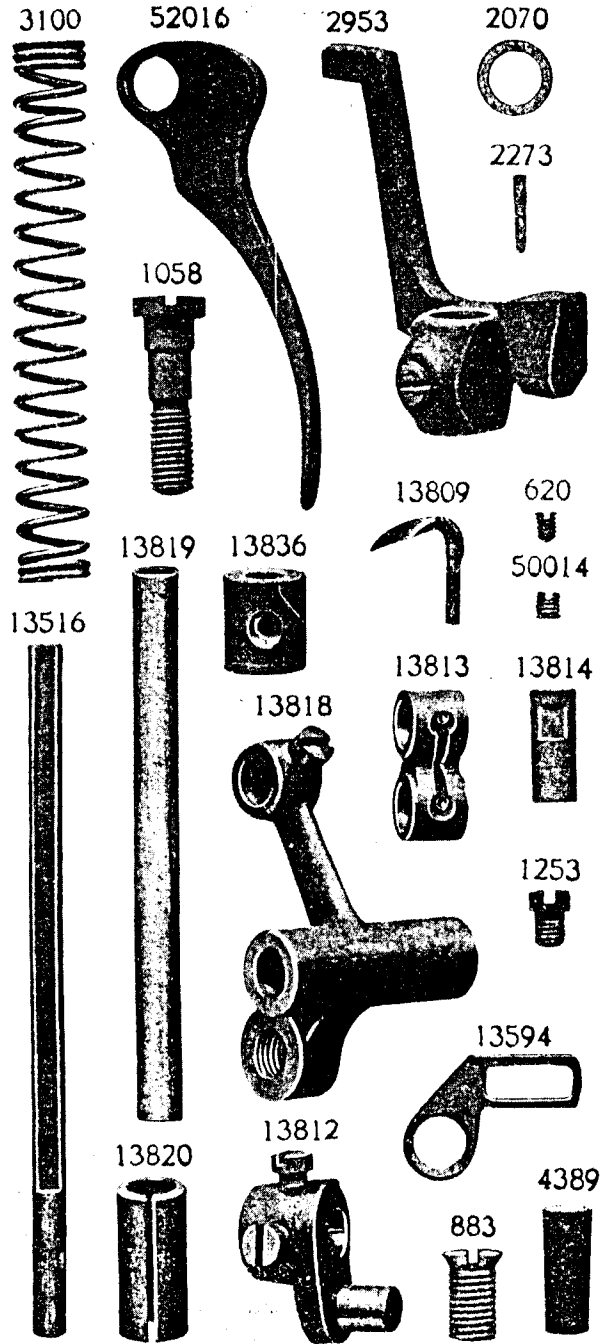
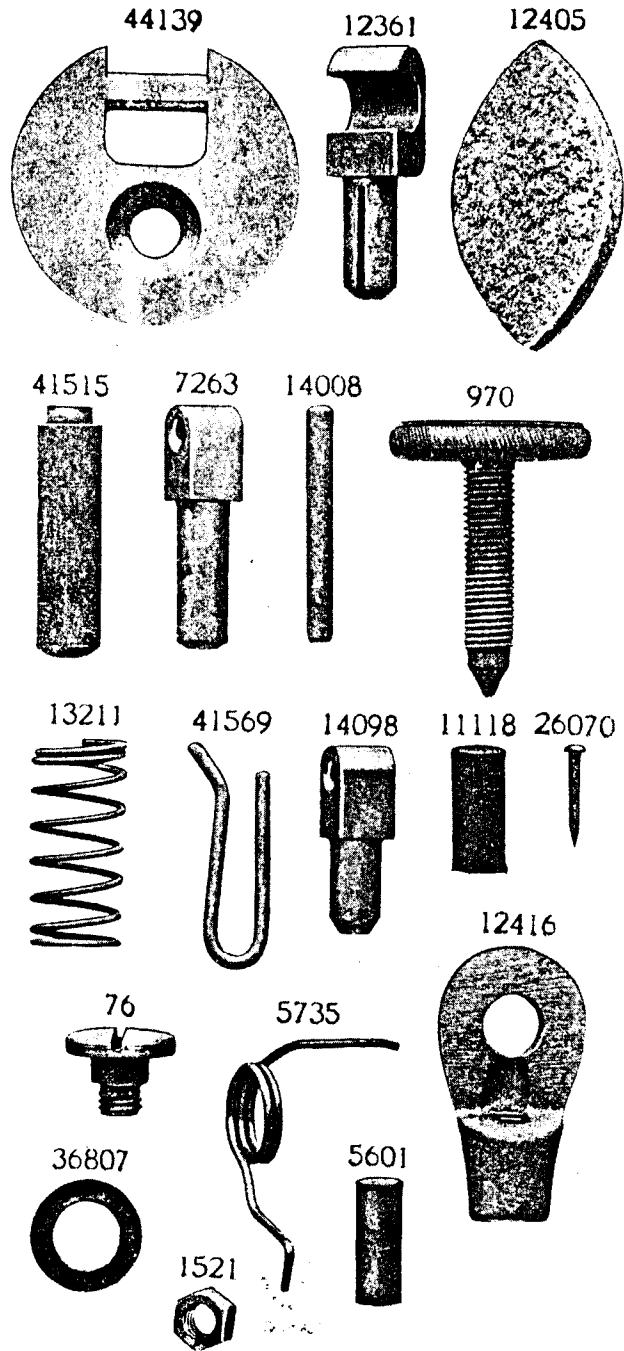

PLATE 7446—FULL SIZE



From the library of: Diamond Needle Corp

PLATE 7447—ONE-HALF SIZE

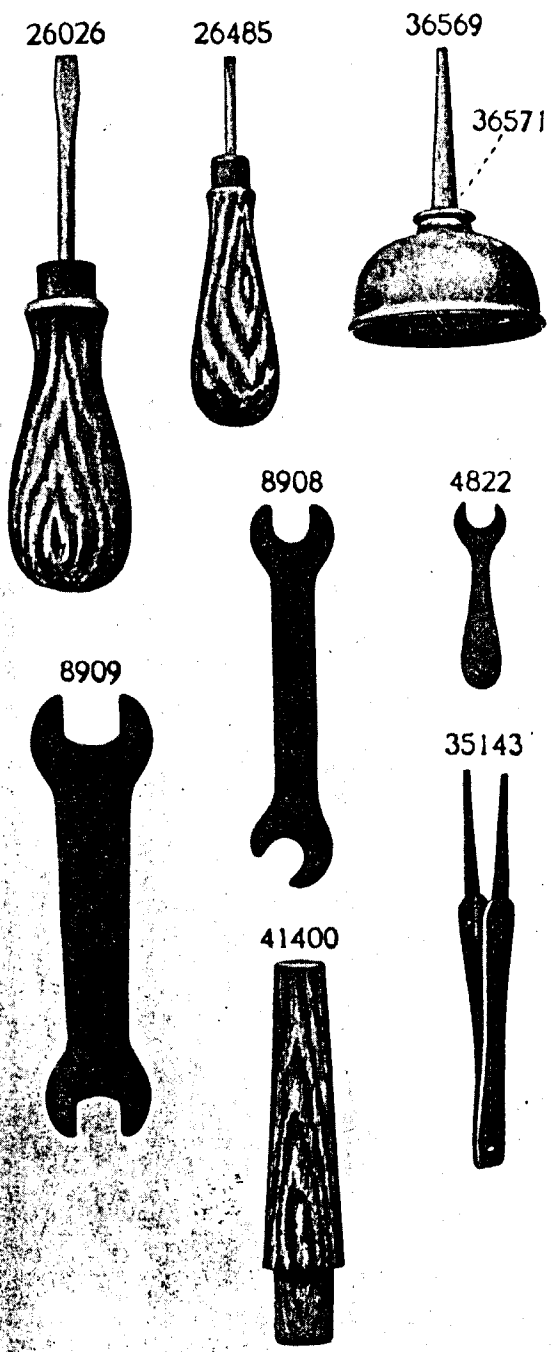
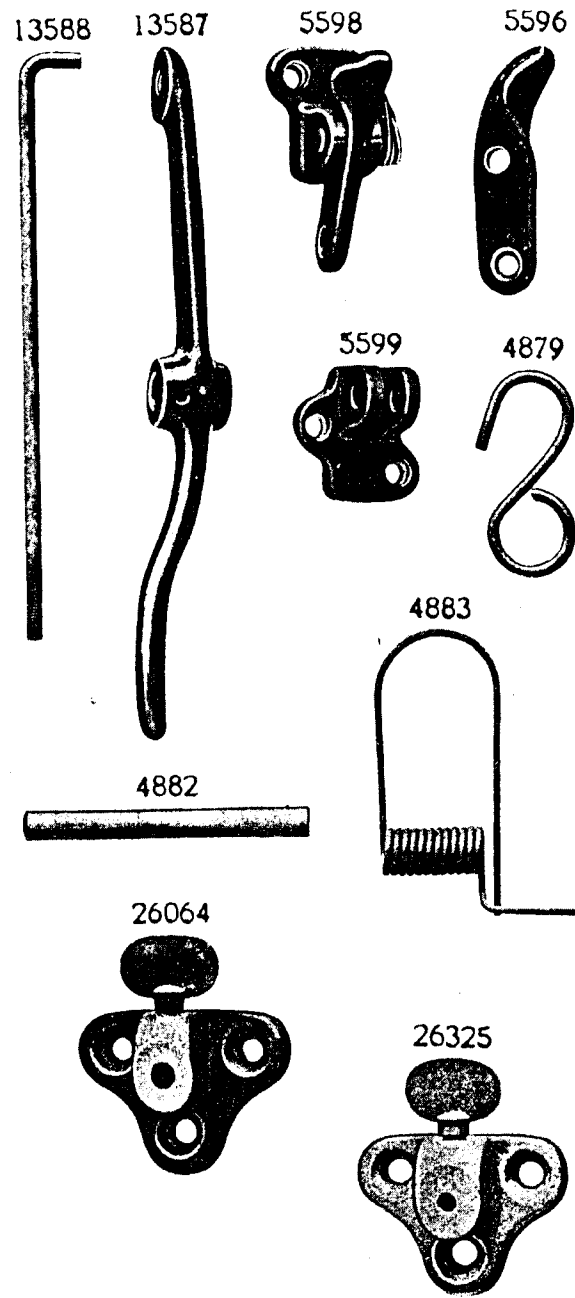

PLATE 7448—ONE-HALF SIZE



From the library of: Diamond Needle Corp

PLATE 7450—FULL SIZE

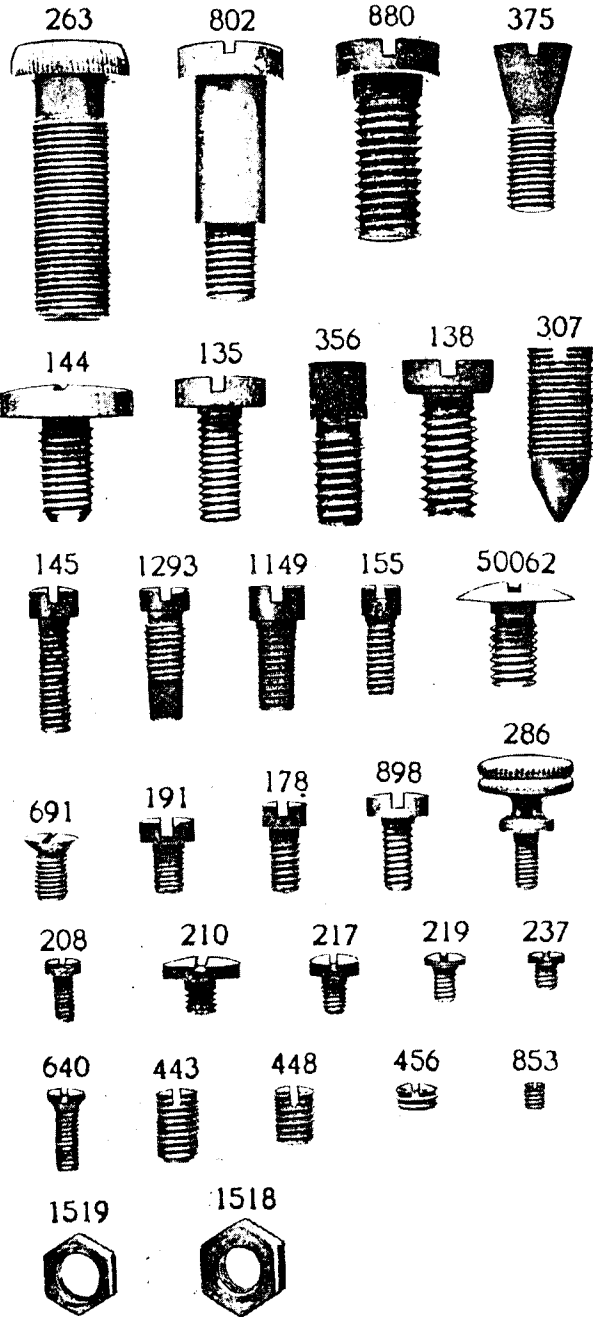
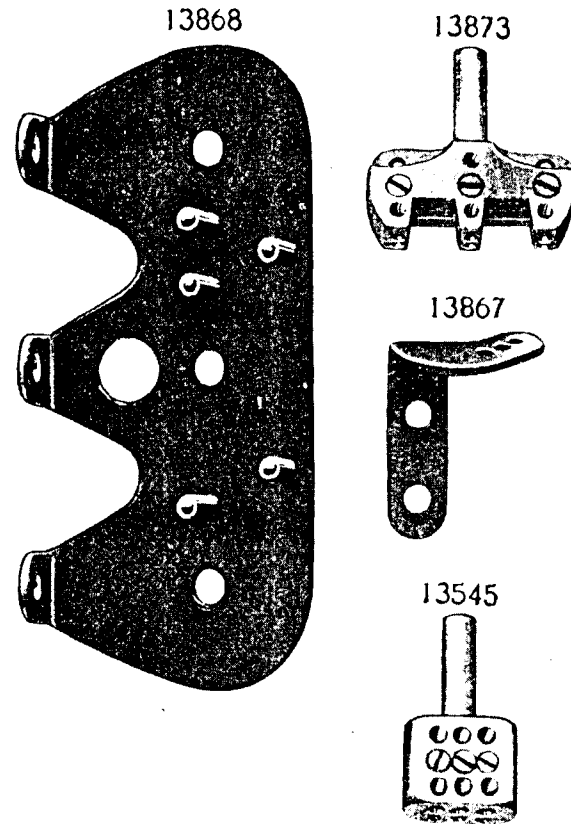

PLATE 7455—FULL SIZE



From the library of: Diamond Needle Corp

PLATE 7456—ONE-HALF SIZE

13851

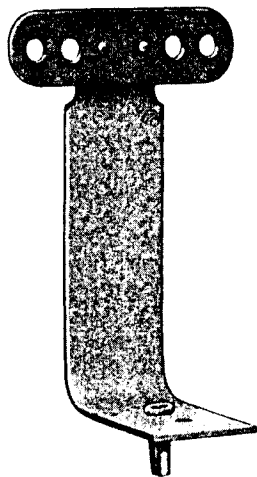

PLATE 7457—FULL SIZE

13854

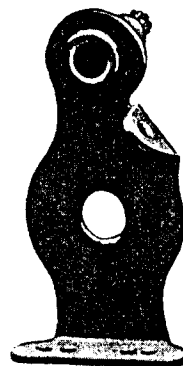

PLATE 7467—FULL SIZE

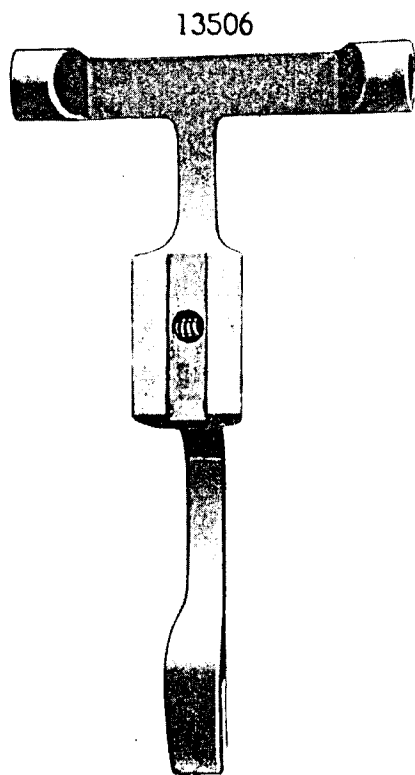
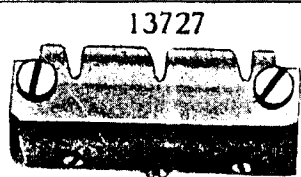

PLATE 7482—FULL SIZE

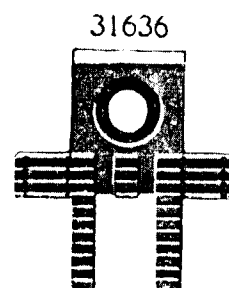
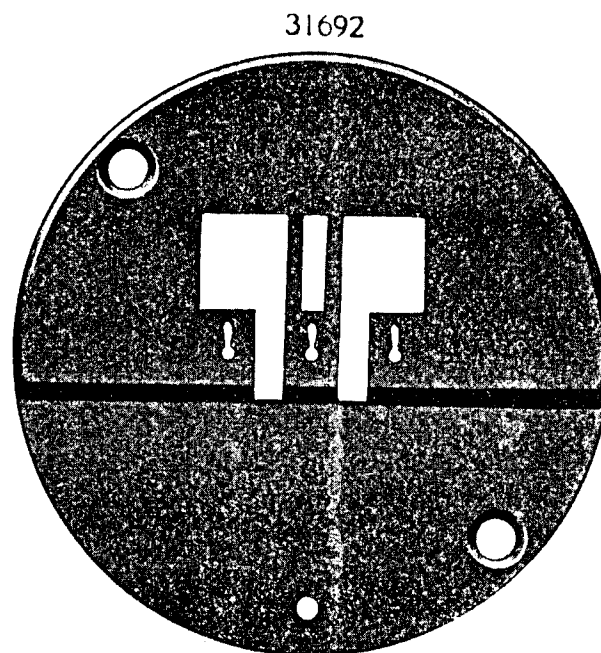
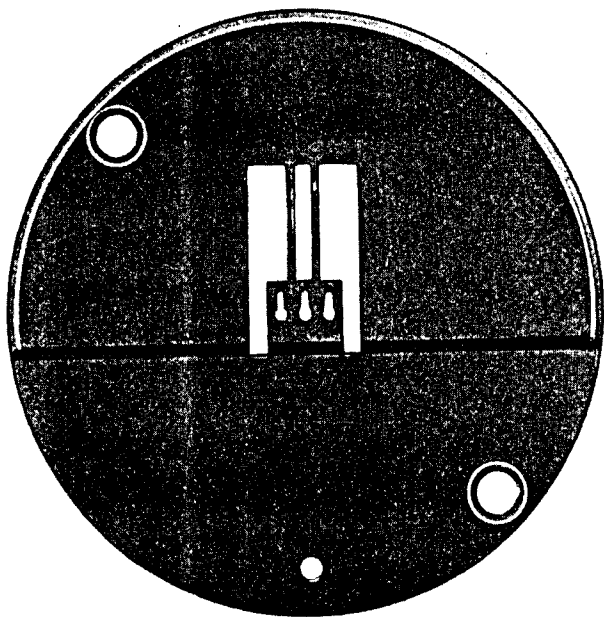

PLATE 7483—FULL SIZE

31693



30243



PLATE 8753—FULL SIZE

120341



13617



13940

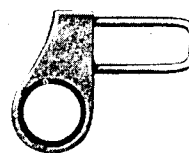

225326



13929



13930



201696



225322



200383



56865



56864



15486



1513



201018



1454



315

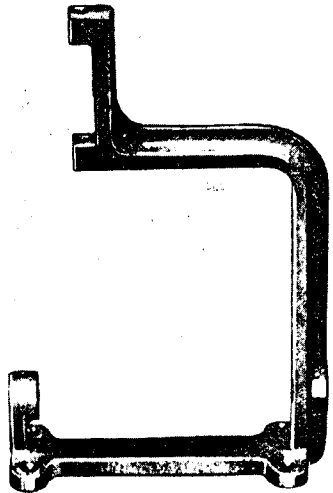

PLATE 8754—ONE-FOURTH SIZE

13928



27978



27972



27979

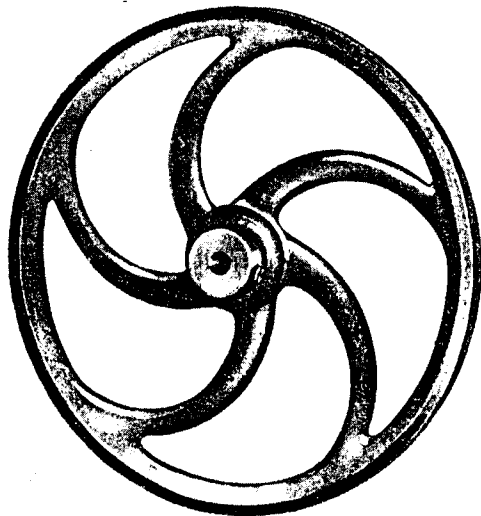

PLATE 8755—ONE-FOURTH SIZE

259143



225391

225324

225259

225388

150203

225257

202490

